

Pressure measurement

Powerful instruments for process pressure, differential pressure, level and flow



Endress+Hauser – Your partner

Endress+Hauser is a global leader in measurement instrumentation, services and solutions for industrial process engineering

With dedicated sales centers and a strong network of partners, Endress+Hauser guarantees competent worldwide support. Our production centers in twelve countries meet your needs and requirements quickly and effectively. The Group is managed and coordinated by a holding company in Reinach, Switzerland. As a successful family-owned business, Endress+Hauser is set to remain independent and self-reliant.

Endress+Hauser provides sensors, instruments, systems and services for level, flow, pressure and temperature measurement as well as analytics and data acquisition. The company supports you with automation engineering, logistics and IT services and solutions. Our products set standards in quality and technology.

We work closely with the chemical, petrochemical, food and beverage, oil and gas, water and wastewater, power and energy, life science, primary and metal, renewable energy, pulp and paper and shipbuilding industries. Endress+Hauser helps customers to optimize their processes in terms of reliability, safety, economic efficiency and environmental impact.

Competence center for pressure measurement

Endress+Hauser Maulburg is one of the leading producers of level and pressure instrumentation. The company employs more than 2,000 associates world-wide. Headquartered in Maulburg, near to the French and Swiss border, Endress+Hauser has also sites in Kassel and Stahnsdorf. Associated Product Centers in Greenwood (USA), Suzhou (China), Yamanashi (Japan), Aurangabad (India) and Itatiba (Brazil) are responsible for customized final assembly and calibration of measuring instruments.



To learn more about Endress+Hauser, visit:
www.endress.com

Competence in pressure measurement

265 patents in 30 years. Millions of satisfied customers.

For over 30 years we are pushing pressure measurement with intelligent innovations. The core of all our innovations is to create sustainable advantages and cost savings for customers: Be it with five sensor technologies, control and spare parts concepts or software tooling.

Application examples come from all industry sectors: From the chemical and petrochemical industries to the pharmaceutical, food and environmental industries, in power plants or in shipbuilding or automotive industries. The broad range of products makes it easy to find the ideal solution. No product is suited to all application areas. Therefore measuring systems must work reliably under the conditions of a particular application while meeting economic expectations.

As the only supplier of pressure instrumentation we offer the right sensor for any application:

- **Oil-free capacitance ceramic cell Ceraphire:** Extremely robust and vacuum resistant. Including membrane breakage detection; optional for cold applications with condensation.
- **Silicon cell with process membrane:** No sealing, small flush-mounted process connections, high pressures. Optional with MID certificate.
- **Unique condensation tight Contite cell:** Minimal influence of temperature shocks.
- **Fully welded diaphragm seals with or without capillaries:** Filling oils depending on the application.
- **Function monitored differential pressure cell with overload resistant membrane:** Accurate measurement of small differential pressures with high one-sided or two-sided static pressures.

Depending on the application you can choose from three instrument classes with the optimum price-performance-ratio:

- **S-Class (70-90):** Highest precision and maximum safety
- **M-Class (40-60):** Versatile for high process requirements
- **T-Class (10-30):** Cost-effective instruments for standard applications

You will gain the following advantages:

- **Industry optimized versions** with all required materials, accessories and approvals
- **Tools to make your work easier:**
 - Applicator Selection: Selection of transmitters
 - Applicator Sizing Flow: Design of flow measurement systems (e.g. inlet and outlet run, pressure loss, ...)
 - Applicator Sizing Diaphragm Seal: Design of diaphragm seal systems (e.g. application limitations, temperature influences, ...)
 - Online Shop: Information on spare parts and delivery times

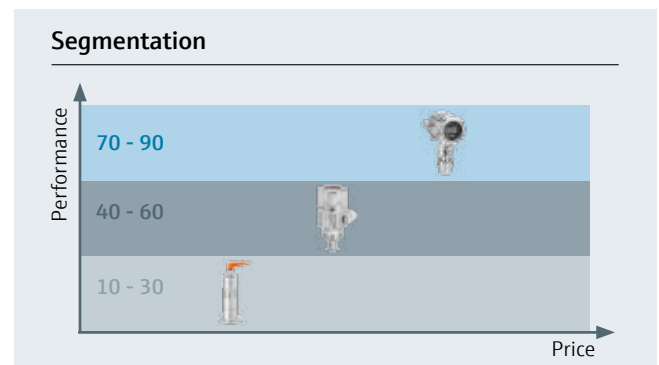

History of pressure measurement at Endress+Hauser

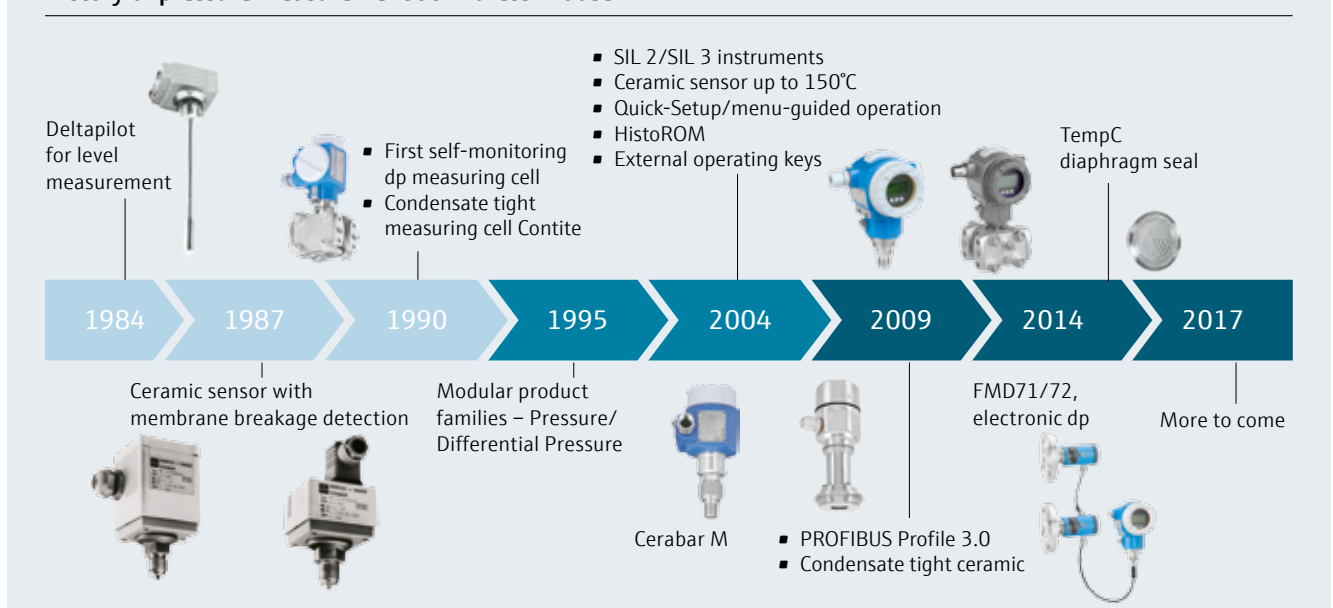



Fuel for thought

With vast experience in the oil & gas sector, we help you to perform, comply and thrive

From exploration to refinery, from storage to distribution, from plant upgrades to new projects, we have the application expertise to help you succeed.

At a time when the sector faces skills shortages and regulations tightening, our organization is here across the full life cycle of your project always with your deadlines in mind.

While complexity of facilities and processes are ever increasing, and downtime must be reduced, your competitiveness is enhanced with reliable, accurate and traceable asset information.

In short, you need to do more with less, benefiting from a stable partner who is here for the long haul and ready across the globe, offering:

- Assured plant safety
- Optimized return on investment
- Best-fit products, solutions and services



Advantages at a glance

- Mitigating risks by using state of the art technology meeting highest demands with regard to Functional Safety (IEC 61508) and mechanical integrity (e.g. gastight feedthrough)
- Minimizing operational costs through efficient proof testing concepts, predictive maintenance and innovative data management
- Meeting internationally recognized standards and recommendations such as: API, OIML, ASME, NORSOK, NACE etc.
- Increasing plant availability with innovative technologies particularly designed for oil and gas industry applications

Product highlights



Cerabar PMP71

Digital pressure transmitter with fully welded metal sensor

For pressure, level, volume or mass measurement in liquids or gases. Designed for high pressure applications up to 700bar.



Cerabar PMC71

Digital pressure transmitter with oil-free ceramic sensor

For pressure, level, volume or mass measurement in liquids and gases. High degree of system safety thanks to vacuum-proof ceramic membrane with integrated membrane breakage detection.



Deltabar FMD72

Utilizing two fully welded metal sensor modules and one transmitter

The electronic differential pressure system eliminates traditional mechanical issues resulting in greater process availability and reliability.



Deltabar PMD75

Differential pressure transmitter with metal sensor

For continuous measurement of pressure differences in liquids, vapours and gases. Extreme pressure resistance thanks to internal overload membrane especially for small measuring ranges.



Deltabar FMD77/FMD78

Differential pressure transmitter with one/two diaphragm seals

For continuous measurement of pressure differences in liquids, vapours, gases and dusts. Especially for applications with high temperatures and rough conditions.



Cerabar PMP75

Digital pressure transmitter with fully welded diaphragm seal

For pressure, level, volume or mass measurement in liquids or gases.

Maximum process safety and long-term reliability

Upstream and downstream applications as found in refineries, FPSO ships and offshore oil platforms. They require reliable pressure and differential transmitters that meet the highest safety standards and "last a lifetime". Robust stainless steel housings, sensors with highest accuracy and long-term stability and a wide choice of special materials ensure maximum process safety and measurement reliability.

Our solutions go beyond safety, efficiency and compliance.

We offer:

- Highest safety due to secondary containment with gastight feedthrough with functional safety capabilities up to SIL 3, certified to IEC 61508
- Easy ordering and archiving of specific documentation, e.g. NACE, PMI and shipbuilding certificates, welding maps and others
- Cost savings with modular concept for easy replacement of sensor, display or electronics
- Easy menu-guided commissioning via local display, 4 to 20mA with HART, PROFIBUS PA, FOUNDATION Fieldbus
- Safe and easy engineering documentation with engineering tool Applicator for optimized layout of diaphragm seal systems, dp flow measuring points and level measurement with electronic dp





Global chemicals, competitive and safe

Get the extra project skill and know-how you need to boost your plant's safe performance

You gain concrete benefits from a partner who has first-hand knowledge of your sector's issues around the globe: on increased safety, on environmental protection, on over-supply leading to cost pressure and on finding engineering support and service when required. You can rely on our help to become more competitive in your line of business.

With a long history of industry firsts we have grown with the sector by listening, acting and innovating to better serve you with:

- Safety, built in
- The technology to lead
- Best-fit project management



Advantages at a glance

- Meeting internationally recognized standards/ recommendations: NAMUR, WHG, IP, ASME, NACE, API, IEC 17025, MID, OIML
- Internationally accepted hazardous area approvals: ATEX, IECEx, FM/CSA, NEPSI, TIIS, INMETRO
- Use of state of the art technology – functional safety according to IEC 61508 (up to SIL 3)
- Uniform operating safety by design concepts for simple and safe operations
- Optimized material availability and minimized stocks through inventory management solutions

Product highlights



Cerabar PMC71

Digital pressure transmitter with oil-free ceramic sensor

For pressure, level, volume or mass measurement in liquids and gases. High degree of system safety thanks to vacuum-proof ceramic membrane with integrated breakage detection.



Cerabar PMP75

Digital pressure transmitter with fully welded diaphragm seal

For pressure, level, volume or mass measurement in liquids or gases. Suitable for high pressure as well as extreme process temperature applications.



Deltabar FMD77

Differential pressure transmitter with one diaphragm seal

For continuous level measurement in liquids.



Deltabar PMD75

Differential pressure transmitter

For continuous measurement of pressure differences in liquids, vapours and gases. Extreme pressure resistance thanks to internal overload membrane especially for small measuring ranges.



Deltabar FMD71

Utilizing two ceramic sensor modules and one transmitter

The electronic differential pressure system eliminates traditional mechanical issues resulting in greater process availability and reliability.



Deltabar with primary elements

Differential pressure flow measurement

The universal measuring system using orifice plates, pitot tubes, nozzles or venturis.

Maximum process safety and reliability

Pressure measurement in pressurized pipes with aggressive media and level measurements in vacuum distillation columns or rectifiers are typical applications for the Cerabar S pressure and Deltabar S differential pressure product families. Developed according to IEC 61508, highest process safety is realized with the two chamber housing with secondary containment for measurements with functional safety up to SIL 3. Sensors with highest accuracy and long-term stability and a wide choice of special materials and process connections ensure maximum process safety and measurement reliability.

Our solutions go beyond safety, efficiency and compliance.

We offer:

- Highest process reliability using application specific materials such as 316L, Ceramic, Alloy C, Monel, Tantal, Gold-Rhodium, PTFE, ...
- Maximum process safety and reliability using robust and vacuum-resistant ceramic cells with integrated membrane breakage detection for pressure measurements even below 1mbar (0.0145psi) absolute
- Cost savings with modular concept for easy replacement of sensor, display or electronics
- Easy menu-guided commissioning via local display, 4 to 20mA with HART, PROFIBUS PA, FOUNDATION Fieldbus





Extracting more from less

In a world of lower grades, skills gaps and excavation challenges - we can help you hit your targets

We've seen how lower grades are driving an acute need for ever-better automation and controls. You are also facing emerging skills gap, requiring better-informed industry partners.

At the same time, energy costs are only going one way, and the legislative environment is becoming increasingly stringent.

Tough challenges call for experienced heads who can:

- Reduce your metal and mineral production costs
- Keep your plant safe
- Boost compliance and responsibility



Advantages at a glance

- Complete product basket for all applications, specifically in harsh environments
- Advanced diagnostic functionalities to make the process more safe and reliable
- Savings in raw material, water, energy and labor through accurate data of critical and quality relevant points in your process

Product highlights

Cerabar PMC71



Digital pressure transmitter with oil-free ceramic sensor

For pressure, level, volume or mass measurement in liquids and gases. High degree of system safety thanks to abrasion-proof ceramic membrane with integrated breakage detection.

Cerabar PMC51



Digital pressure transmitter with oil-free ceramic sensor

For pressure, level, volume or mass measurement in liquids and gases. High degree of system safety thanks to robust abrasion-proof ceramic membrane with integrated breakage detection.

Cerabar PMC21



Cost-effective pressure transducer with oil-free ceramic sensor

For absolute and gauge pressure measurement. Fit purpose device.



Deltabar FMD71

Utilizing two ceramic sensor modules and one transmitter

The electronic differential pressure system eliminates traditional mechanical issues resulting in greater process availability and reliability.

Deltabar PMD55



Differential pressure transmitter with metal sensor

Compact transmitter for flow, level and filter applications.



Deltabar with primary elements

Differential pressure flow measurement

The universal measuring system using orifice plates, pitot tubes, nozzles or venturis.

Robust for maximum process safety, efficiency and reliability

The application requirements typically found in cement mills, foundries or mining applications require pressure and differential transmitters that are robust and suitable for the rough application conditions often found in these industries. The ceramic pressure sensor is predestined for abrasive applications due the 99.9% pure Al_2O_3 material and membrane thickness that result in an extremely robust solution.

With a segmented portfolio offering, from highest accuracy and long-term stability to small and compact design, the perfect fit is always given. Our solutions go beyond safety and efficiency.

- Maximum process safety and reliability with robust and abrasion-resistant ceramic cells with integrated membrane breakage detection
- Easy menu-guided commissioning via local display, 4 to 20mA with HART, PROFIBUS PA, FOUNDATION Fieldbus
- Safe and easy engineering documentation with engineering tool Applicator for optimized layout of dp flow measuring points, diaphragm seal systems and level measurement with electronic dp
- Minimized maintenance effort, e.g. with retractable pressure transmitter with ceramic membrane for thickeners





Nourishing your productivity

Your global partner for accurate measurements and expert support in food and beverages automation

From hygiene regulations and food safety to the basic demands of reliability and uptime, high quality food & beverage producers profit from our experience in more than 100 countries.

Get it right the first time and make your safe choice:

- Constant food quality & compliance
- Resources savings
- An expert partner



Advantages at a glance

- Complete basket of 3-A, FDA and EHEDG approved level measurement solutions
- Food safety and reliability due to instruments designed and manufactured specifically for all requirements in food & beverage industry
- Savings in raw material, water, energy and labor through accurate data of critical and quality relevant points in your process
- Optimized material availability and minimized stocks through inventory management solutions

Product highlights



Deltapilot FMB50/FMB70

Highest performance pressure sensor for precise hydrostatic level measurement

Due to its fully temperature compensated and condensation proof Contite cell, Deltapilot is the first choice in condensation applications.



Deltabar FMD71/FMD72

Utilizing two ceramic or fully welded metal sensor modules and one transmitter

The electronic differential pressure system eliminates traditional mechanical issues resulting in greater process availability and reliability.



Cerabar PMC51

Pressure transmitter with oil-free ceramic sensor

High degree of application safety thanks to permanent self-monitoring and fully overload resistant sensor cell, suitable also for condensation applications.



Cerabar PMP55

Digital pressure transmitter with fully welded diaphragm seal

A wide range of diaphragm seals with different process connections, oil fillings and membrane materials allow the adaption to many processes. New TempC Membrane minimizes temperature effects.



Cerabar PMP51

Universal pressure transmitter with compact sensor module

Temperature compensated and with a high variety of process connections and measuring ranges, the PMP51 is the most universal pressure transmitter on the market.



Cerabar PMP23

Fit-for-purpose pressure transducer

The fully welded process connections in 316L paired with IP69 capability in compact version make this transducer the perfect fit for simple monitoring applications in the food and beverages industry.

Maximum food safety and reliability

The application requirements in food and beverages are very challenging especially for pressure sensors: Rapid temperature changes due to CIP/SIP cleaning, wash-down applications requiring IP69 or condensation formation due to cold processes.

With a segmented portfolio offering, from highest accuracy and long-term stability to small and compact design, the perfect fit is always given. The hygienic design is documented with the industry specific certifications.

With the unique basket of sensor technologies, our pressure portfolio always offers the best solution dependent on the specific application requirement:

- Maximum reliability and process safety with condensation-proof ceramic sensor with membrane breakage detection
- Deltapilot with hermetically welded condensation-proof Contite cell
- Highest accuracy with temperature compensated silicon sensor with small flush-mounted process connections
- Diaphragm seals with patented TempC Membrane for minimal influence due to process and ambient temperature fluctuations





The pulse of life sciences

Trust a reliable partner who puts quality, compliance and cost control at the heart of life sciences

It is a daily task to meet stringent GxP regulations and productivity goals throughout your product lifecycle. You can count on our world-class instruments, designed to ASME-BPE standards, but also our highly qualified engineering input and experienced service teams. We partner with you to generate process optimization, higher plant availability and continuous improvement. Our experience, gained at the heart of the sector, will help you to:

- Streamline your projects
- Attain operational experience
- Make the right decisions

✓ Advantages at a glance

- Measurement instruments that fully comply with the numerous requirements, codes and standards, such as FDA, ISPE, GAMP, ASME-BPE, EU1935/2004, etc.
- Advanced diagnostics guarantees highest process safety and efficiency
- Products designed for high temperatures and pressures during CIP and SIP processes
- Delivery of products with all required approvals (material certificates for the process wetted parts, certificates of compliance, calibration certificates, surface roughness finish certificates, test reports, etc.)

Product highlights



Cerabar PMP51

Digital pressure transmitter with fully welded metal sensor

For pressure, level, volume or mass measurement in liquids or gases. Available with small flush-mounted process connections.



Deltapilot FMB50

Compact pressure sensor with the Contite measuring cell

Made for level measurement in liquid and paste-like media in open or closed containers.



Cerabar PMC51

Digital pressure transmitter with oil-free ceramic sensor

For pressure, level, volume or mass measurement in liquids and gases. High degree of system safety thanks to vacuum-proof ceramic membrane with integrated breakage detection.



Cerabar PMP75

Digital pressure transmitter with fully welded diaphragm seal

For pressure, level, volume or mass measurement in liquids or gases. Highest accuracy reproducibility and process safety with patented TempC Membrane.



Deltabar FMD72

Utilizing two fully welded metal sensor modules and one transmitter

The electronic differential pressure system eliminates traditional mechanical issues resulting in greater process availability and reliability.



Deltabar FMD78

Differential pressure transmitter with two diaphragm seals

For continuous measurement of pressure differences in liquids, vapours, gases and dusts. Highest accuracy reproducibility and process safety with patented TempC Membrane.

Compliance – Reliability – Availability

The application requirements in the Life Sciences applications are very challenging: Temperature shocks due to sterilization, small pipe diameters that require flush-mounted process connections, right documentation for GMP regulated facilities (IQ/OQ) etc.

With a dedicated product portfolio offering, from highest accuracy and long-term stability to small and compact design, the perfect fit is always given. Options for electro-polishing, USP Class VI elastomers and Certificate of Compliance (CoC) according to ASME BPE ensure the suitability also for biotech applications.

With the unique basket of sensor technologies, the pressure portfolio of Endress+Hauser always offers the best solution dependent on the specific application requirement:

- Standard process temperature rating of 150°C for pressure sensors without diaphragm seal
- Oil-free ceramic sensor with integrated membrane breakage detection assures maximum process safety and reduces the risk of contamination
- Highest accuracy with temperature compensated silicon sensor with small flush-mounted process connections
- Highest accuracy using diaphragm seals with patented TempC Membrane: Ensures minimal temperature effects and short recovery times also with small membrane diameters
- Easy ordering and archiving of specific documentation





Water is our life

Water quality, discharges, regulations, the environment... just rely on a trusted partner

As budgets shrink and legislative demands soar, we bring expertise for challenging needs.

Safe potable water... discharges, environmental penalties... water infrastructure for developing countries... energy monitoring... the rising quantities of sludge from wastewater treatment and the opportunities they create for biogas. We make sense of it all, with experienced thinking supported by process technology solutions for your every need.

Through working with water in over 100 countries, Endress+Hauser offers a refreshing alternative.

- Improve plant safety and availability
- Optimize costs in your internal water processes
- Support your risk and failure management



Advantages at a glance

- Cost-effective product and service portfolio for any applications, e.g. for drinking water, wastewater and sewage, desalination
- Meeting internationally recognized standards/ recommendations for drinking water applications
- Highest efficiency by easy commissioning, operation and maintenance of instruments

Product highlights



Cerabar PMC51

Digital pressure transmitter with oil-free ceramic sensor

For pressure, level, volume or mass measurement in liquids and gases. High degree of system safety thanks to robust ceramic membrane with integrated breakage detection.



Deltabar PMD55

Differential pressure transmitter

Compact transmitter for continuous measurement of pressure differences in liquids, vapours and gases.



Deltapilot FMB53

Pressure sensor with the Contite measuring cell

Made for level measurement in liquid and paste-like media in open or closed containers. Ideal solution for applications with foam formation.



Cerabar PMP11/PMC11

Cost-effective pressure transducer with oil-free ceramic sensor or fully welded metal sensor

For continuous gauge pressure measurement in gases or liquids.



Waterpilot FMX21

Reliable and robust level probe with ceramic measuring cell

Certified for drinking water with a robust ceramic sensor and integrated temperature measurement.



Ceraphant PTC31B/PTP31B

Cost-effective pressure switch with oil-free ceramic sensor or fully welded metal sensor

For safe measurement and monitoring of absolute and gauge pressure.

Easy to use and absolute reliable

Water and wastewater treatment plants or level probes for surface and/or groundwater applications require robust sensors that are suitable for the ambient conditions often found in these industries. The oil-free and robust ceramic pressure sensor is predestined for these applications due to the membrane thickness and resulting robustness. The available housings, electronic inserts and available accessories ensure easy mounting and commissioning.

With a segmented portfolio offering, from highest accuracy and long-term stability to small and compact design, the perfect fit is always given.

Our solutions go beyond safety, efficiency and compliance.

We offer:

- Easy on-site commissioning with operation via local LCD display
- Rod / Rope versions with different cable materials ensure wide use
- International drinking water approvals





Power up your plant

Power plants play a vital role. We help minimize downtime whilst delivering safety and productivity

Your plant needs a multi-skilled, versatile partner. You need reliable solutions that meet your application requirements and industry quality standards. And you may need to upgrade ageing plants with proven and state-of-the-art technologies, to keep the output consistently high. As the industry shifts towards natural gas, renewables and the new market dynamics driven by shale gas, our mission is to provide the all-round support and experience you need.

This includes elevated standards of safety for your staff. And the ability to meet even-higher environmental demands in flue gas cleaning processes such as SCR catalysts for nitrogen oxide reduction, electrostatic precipitators (ESPs) for particle separation, and limestone scrubbing processes for desulphurization.

When you choose us, you:

- Boost the efficiency of your plant
- Heighten safety
- Maintain expertise

✓ Advantages at a glance

- Functional safety: IEC 61508 SIL 2/3 certified
- Intelligent instruments with continuous self-monitoring
- Pressure directives such as PED, AD2000, CRN, EN13480
- Minimized downtime and highest safety through modern instrumentation

Product highlights



Cerabar PMP71

Digital pressure transmitter with fully welded metal sensor

For pressure, level, volume or mass measurement in liquids or gases. Designed for high pressure applications up to 700bar (10,500psi).



Cerabar PMP51

Digital pressure transmitter with fully welded metal sensor

For pressure, level, volume or mass measurement in liquids or gases. Designed for high pressure applications up to 400bar (6,000psi).



Deltabar PMD75

Differential pressure transmitter

For continuous measurement of pressure differences in liquids, vapours and gases. Extreme pressure resistance thanks to internal overload membrane especially for small measuring ranges. High accuracy up to 0.035%.



Cerabar PMP75

Digital pressure transmitter with fully welded diaphragm seal

For pressure, level, volume or mass measurement in liquids or gases. Up to 400°C (752°F).



Deltabar with primary elements

Differential pressure flow measurement

The universal measuring system using orifice plates, pitot tubes or venturis. For applications up to 1,000°C (1,832°F) and 420bar (6,090psi). Standardized measuring principle according to ISO 5167.



Cerabar PMP21

Cost-effective pressure transducer with fully welded metal sensor

For absolute and gauge pressure measurement up to 400bar (6,000psi).

Robust for maximum process safety and reliability

Pressure measurement in tanks and pressurised pipes are typical applications for the Cerabar S pressure and Deltabar S differential product families. Developed according to IEC 61508, highest process safety is realized with the two chamber housing with secondary containment for measurements with functional safety up to SIL 3. Sensors with highest accuracy and long-term stability ensure maximum process safety and measurement reliability.







Our solutions go beyond safety and efficiency.

We offer:

- Pressure transmitters for pressures up to 700bar (10,500psi) and dp transmitters with pressure ratings up to 420bar (6,090psi)
- Cost savings with modular concept for easy replacement of sensor, display or electronics
- Easy menu-guided commissioning via local display, 4 to 20mA with HART, PROFIBUS PA, FOUNDATION Fieldbus
- Safe and easy engineering documentation with engineering tool Applicator for optimized layout of diaphragm seal systems, dp flow measuring points and level measurement with electronic dp

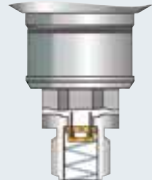
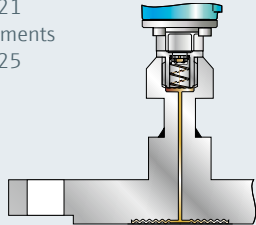
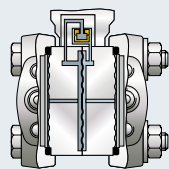
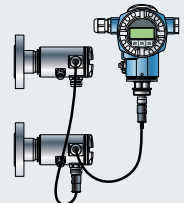
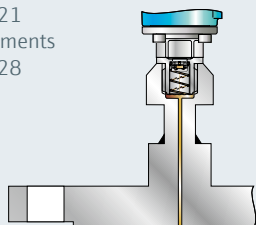

Overview of sensor technologies

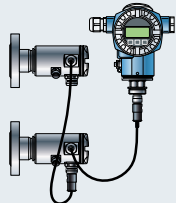
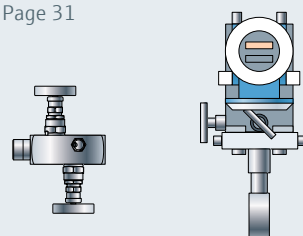
	Description	Measuring principle		
Gauge pressure	Maximum performance and reliability with the right sensor technology	Ceramic measuring cell Measuring principle Page 20 Instruments Page 22 	Silicon measuring cell Measuring principle Page 20 Instruments Page 23 	Contite measuring cell Measuring principle Page 20 Instruments Page 24 
Absolute pressure	Maximum performance and reliability with the right sensor technology	Ceramic measuring cell Measuring principle Page 20 Instruments Page 22 	Silicon measuring cell Measuring principle Page 20 Instruments Page 23 	Diaphragm seal Measuring principle Page 21 Instruments Page 25 
Differential pressure	Maximum performance and reliability with the right sensor technology	Silicon measuring cell Measuring principle Page 20 Instruments Page 26 	electronic dp Measuring principle Page 21 Instruments Page 27 With silicon or ceramic measuring cell 	Diaphragm seal Measuring principle Page 21 Instruments Page 28 
Hydrostatic pressure	Maximum performance and reliability with the right sensor technology and system architecture	Ceramic measuring cell Measuring principle Page 20 Instruments Page 22, 27 and 29 	Silicon measuring cell Measuring principle Page 20 Instruments Page 23, 27 	electronic dp Measuring principle Page 21 Instruments Page 27 With silicon or ceramic measuring cell 
Accessories	We offer accessories needed for safe and correct installation of pressure / differential pressure transmitters.	Accessories Page 31 		

Diaphragm seal
 Measuring principle
 Page 21
 Instruments
 Page 25

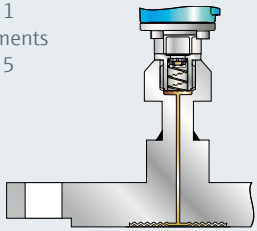

Pressure switch
 Measuring principle
 Page 21
 Instruments
 Page 30

With silicon or ceramic measuring cell

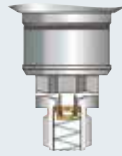

Pressure switch
 Measuring principle
 Page 21
 Instruments
 Page 30

With silicon or ceramic measuring cell

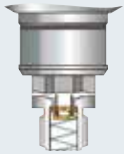

Contite measuring cell
 Measuring principle
 Page 20
 Instruments
 Page 24



Diaphragm seal
 Measuring principle
 Page 21
 Instruments
 Page 28

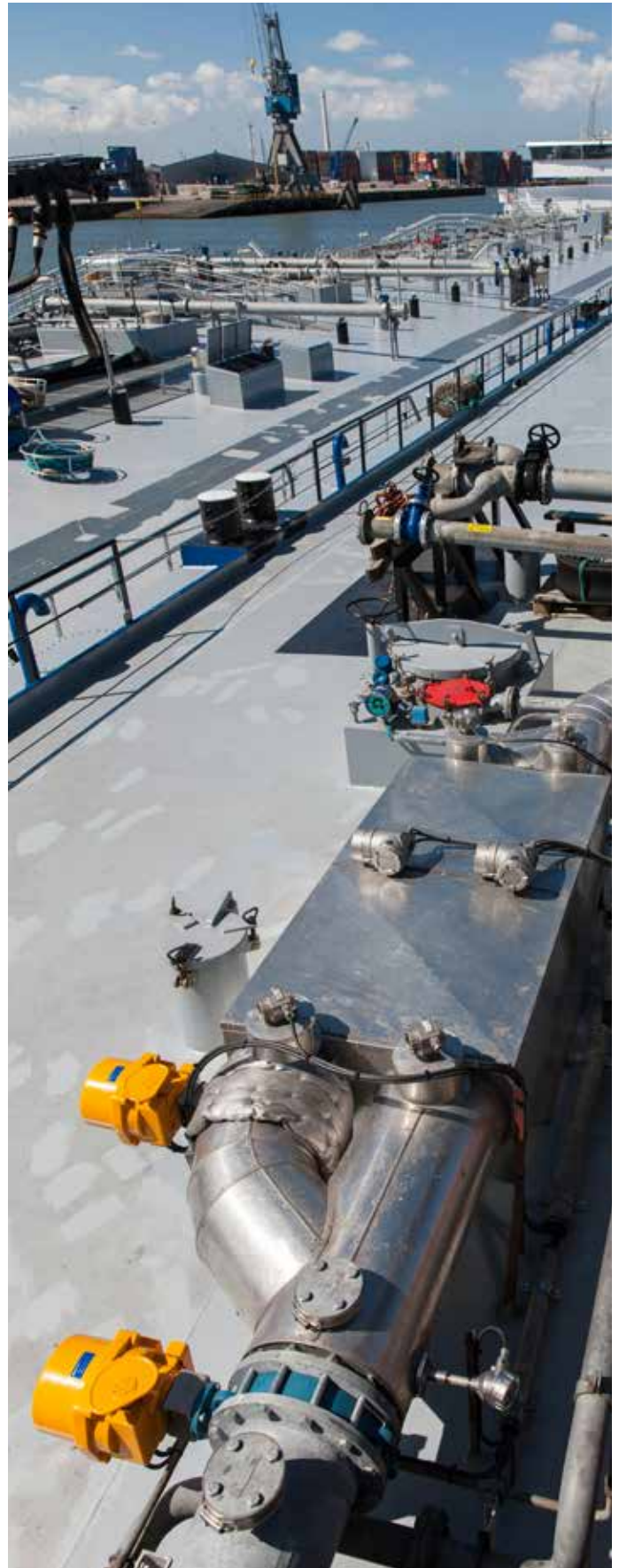
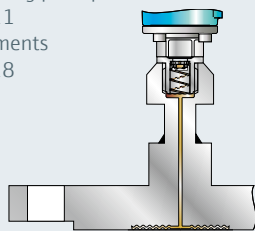

Endress+Hauser sensor technology

The right sensor for every application

Ceramic cell

The ceramic sensor is a dry sensor, i.e. the process pressure acts directly on the robust ceramic process isolating diaphragm and deflects it. A pressure-dependent change in capacitance is measured at the electrodes of the ceramic substrate and the process isolating diaphragm. The measuring range is determined by the thickness of the ceramic process isolating diaphragm.

! Advantages

- Extremely good chemical compatibility and high mechanical stability thanks to ultra-pure 99.9% ceramic
- Suitable for vacuums
- Robust membrane with integrated membrane breakage detection

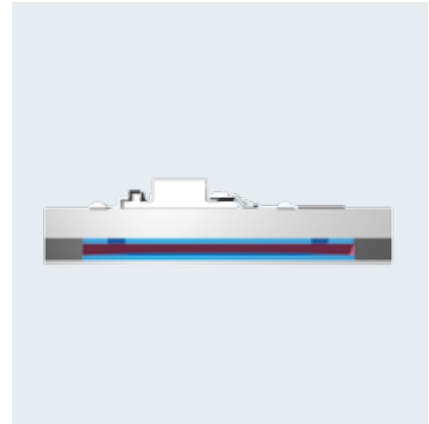

Silicon cell

The operating pressure deflects the process isolating diaphragm and a fill fluid transfers the pressure to a resistance bridge (semiconductor technology). The pressure-dependent change in the bridge output voltage is measured and evaluated.

! Advantages

- For process pressures up to 700bar (10,500psi)
- Small flush-mount process connections
- Guaranteed overload resistance
- Minimal thermal effects

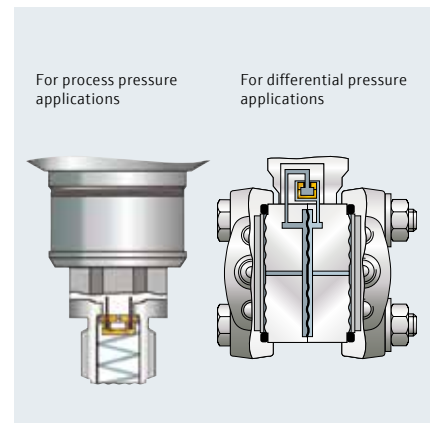

Contite cell

In contrast to conventional gauge pressure sensors, the precision measuring element in the Contite measuring cell is absolutely protected between the process isolating diaphragm and the rear isolating membrane. Thanks to this hermetic sealing of the measuring element, the Contite measuring cell is absolutely insensitive to condensate/condensation and aggressive gases.

! Advantages

- Maximum plant safety provided by one-of-a-kind, condensate-proof Contite measuring cell
- Very good reproducibility and long-term stability even after temperature shocks



Diaphragm seal

The operating pressure acts on the process isolating diaphragm of the diaphragm seal and is transferred to the process isolating diaphragm of the sensor by a diaphragm seal fill fluid. The new TempC Membrane minimizes the influence of process and ambient temperature fluctuations.

! Advantages

- Variety of special materials and process connections
- Process temperatures from -70 up to +400°C (-94 to +752°F)

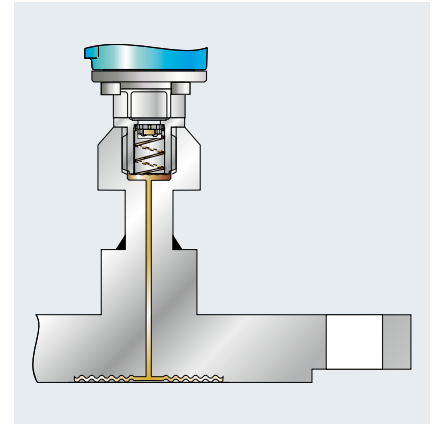

Electronic dp

Deltabar electronic dp is a differential pressure system comprising two sensor modules and one transmitter. In level applications, the high pressure sensor (HP) measures the hydrostatic pressure. The low pressure sensor (LP) measures the head pressure. The level or differential pressure is calculated in the transmitter using these two digital values.

! Advantages

- Better accuracy/reproducibility and cost of ownership compared to capillary and impulse pipe installations
- Fewer spare parts – replace individual components of the system as needed

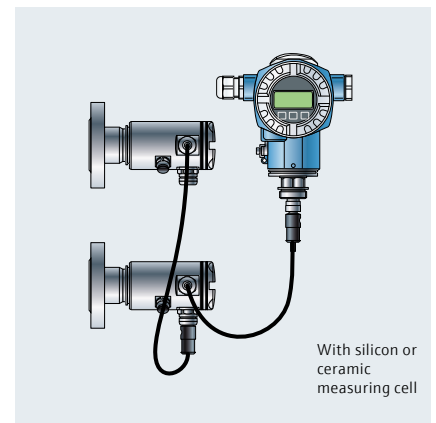

Pressure switch

The pressure switch opens or closes an electrical PNP contact when a certain set pressure has been reached. In addition, a 4 to 20mA output is available.

! Advantages

- Function check and on-site information with LEDs and digital display
- Fully backlit display for easy visibility
- Capacitive push buttons reduce risk of humidity ingress



Cerabar with ceramic cell

Ceramic is one of the hardest materials in the world and ensures the best material properties for the medium. Endress+Hauser capacitance ceramic sensors have membranes up to 30 times thicker than conventional sensors. Even the tiniest of deflections result in measuring signals with the highest accuracy.

The property of the ultra-pure ceramic (99.9%) guarantees high resistance to corrosion, minimal temperature hysteresis and the best overload resistance. The oil-free sensor is the best solution for high vacuum applications.

The integrated membrane breakage detection means additional safety in critical applications.

The unique condensation-proof design of the Cerabar M PMC51 allows the usage of ceramic also in cold media with condensation formation.

Also available with mounted block and bleed valve.



The Cerabar portfolio for absolute, gauge and hydrostatic pressure with ceramic cell



1
Cerabar PMC11/PMC21
Cost-effective pressure transducer with oil-free ceramic sensor

- Process temperature:
-25 to +100°C (-13 to +212°F)
- Measuring ranges:
-1/0 up to +40bar (-15/0 up to +600psi)
- Reference accuracy: ±0.5% / ±0.3%



Advantages Cerabar

- Easy assembly
- Compact design
- Pre-configured measuring ranges available

2
Cerabar M PMC51
Digital pressure transmitter with oil-free ceramic sensor

- Process temperature: -25 up to +130°C (-13 up to +266°F), 150°C (302°F) for 1h
- Measuring ranges:
-1/0 up to +40bar (-15/0 to +600psi)
- Reference accuracy: ±0.15%, "Platinum" ±0.075%



Advantages Cerabar M

- Very simple operation directly on the instrument or via the control system
- Aseptic connections and FDA-conforming materials
- Modular electronics and displays
- Condensate-resistant version
- Compact stainless steel or aluminum housing

3
Cerabar S PMC71
Digital pressure transmitter with oil-free ceramic sensor

- Process temperature:
-25 up to +150°C (-13 to +302°F)
- Measuring ranges:
-1/0 up to +40 bar (-15/0 to +600psi)
- Reference accuracy: ±0.05%, "Platinum" ±0.025%



Advantages Cerabar S

- Highest accuracy and long-term stability
- Reliable data management with HistoROM
- Easy operation with diagnosis functionality
- Two-chamber housing may be turned by 360° for an optimum view of the display
- Functional safety up to SIL 3
- Modular electronics, displays and sensors

Cerabar with silicon cell

As a high-performance solution for high pressure applications up to 700bar (10,500psi) and with the availability of small flush-mount process connections, these sensors meet the highest requirements and work reliably across a large temperature range.

Also available with mounted block and bleed valve.



The Cerabar portfolio for absolute, gauge and hydrostatic pressure with silicon cell



1 2

Cerabar PMP11/PMP21/PMP23

Cost-effective pressure transducer with fully welded metal sensor

- Process temperature: -40 up to +100°C (-40 up to +212°F), 135°C (275°F) for max. 1h
- Measuring ranges: -1/0 up to +400bar (-15/0 up to +6,000psi)
- Reference accuracy: $\pm 0.5\%$ / $\pm 0.3\%$

3

Cerabar M PMP51

Digital pressure transmitter with fully welded metal sensor for measurement

- Process temperature: -40 up to +130°C (-40 up to +266°F), 150°C (302°F) for 1h
- Measuring ranges: -1/0 up to +400bar (-15/0 up to +6,000psi)
- Reference accuracy: $\pm 0.15\%$, "Platinum" $\pm 0.075\%$

4

Cerabar S PMP71

Digital pressure transmitter with fully welded metal sensor

- Process temperature: -40 up to +125°C (-40 to +257°F)
- Measuring ranges: -1/0 up to +700bar (-15/0 to +10,500psi)
- Reference accuracy: $\pm 0.05\%$, "Platinum" $\pm 0.025\%$



Advantages Cerabar

- Easy assembly
- Flush-mounted connections and materials with FDA conformity
- Compact design
- Pre-configured measuring ranges available



Advantages Cerabar M

- Very simple operation directly on the instrument or via the control system
- Small flush-mounted aseptic connections and FDA-conforming materials
- Modular electronics and displays
- Compact stainless steel or aluminum housing



Advantages Cerabar S

- Highest accuracy and long-term stability
- Reliable data management with HistoROM
- Easy operation with diagnosis functionality
- Two-chamber housing may be turned by 360° for an optimum view of the display
- Functional safety up to SIL 3
- Modular electronics, displays and sensors

Deltapilot with Contite cell

The Contite sensor has been specially developed for hydrostatic level measurement based on silicon technology.

With its protection for sensor and cell electronics, the Contite sensor is a convincing solution in the event of severe moisture and condensate formation. The measuring element itself is protected and hermetically sealed between the process membrane and measuring membrane. The process membrane is of Hastelloy C and, thanks to its clever design, insensitive to any kind of build-up. Compact versions with flush-mount process connections are available as well as rod and rope versions with a fixed process connection or rope versions for mounting with suspension clamp.



The Deltapilot portfolio for gauge and hydrostatic pressure with Contite cell

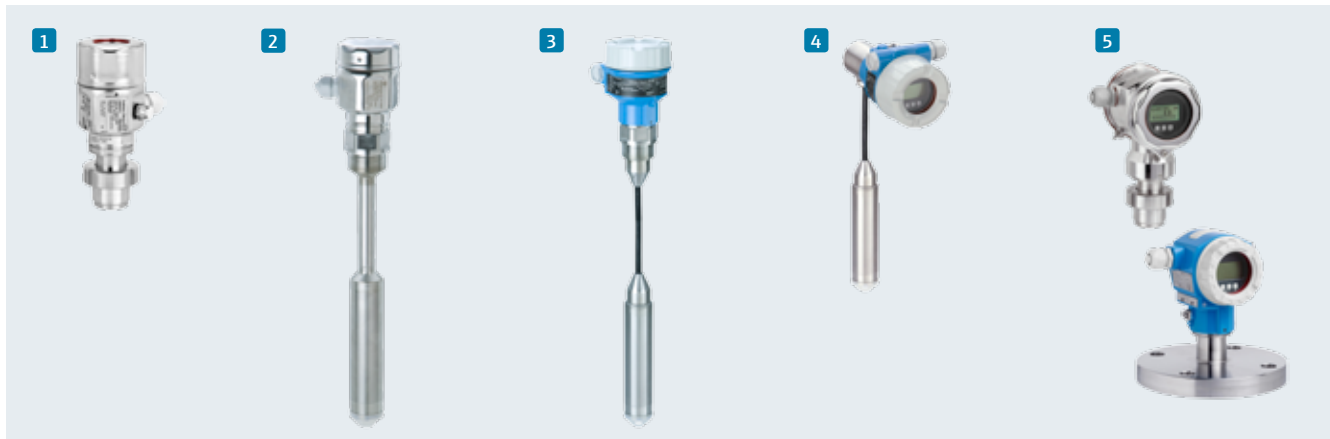

- 1**
Deltapilot M FMB50
Pressure sensor with the Contite measuring cell for hydrostatic level measurement. Compact version
- Process temperature: -10 to +100°C (14 to +212°F), 135°C (275°F) for max. 30 minutes
 - Measuring ranges: 0.1 to 10bar/100m H₂O (1.5 up to 150psi/300ft H₂O)
 - Reference accuracy: ±0.2%, "Platinum" ±0.1%

- 2**
Deltapilot M FMB51
Pressure sensor with the Contite measuring cell for hydrostatic level measurement. Rod version
- Process temperature: -10 to +85°C (-14 to +185°F)
 - Measuring ranges: 0.1 to 10bar/100m H₂O (1.5 up to 150psi/300ft H₂O)
 - Reference accuracy: ±0.2%, "Platinum" ±0.1%

- 3**
Deltapilot M FMB52
Pressure sensor with the Contite measuring cell for hydrostatic level measurement. Cable version
- Process temperature: -10 up to +70°C (14 to +158°F)
 - Measuring ranges: 0.1 to 10bar/100m H₂O (1.5 up to 150psi/300ft H₂O)
 - Reference accuracy: ±0.2%, "Platinum" ±0.1%

✓ Advantages Deltapilot M

- Contite measuring cell: Waterproof, climate-resistant, long-term stable
- Rod/rope versions for installation from the top
- Very simple operation directly at the instrument or via the control system
- Compact stainless steel or aluminum housing

✓ Advantages Deltapilot S

- Highest accuracy and reproducibility, also after extreme ambient and process temperature changes
- Contite measuring cell: Waterproof, climate-resistant and long-term stable
- Very easy operation directly at the instrument or via the control system
- Reliable data management with HistoROM

- 4**
Deltapilot M FMB53
Pressure sensor with the Contite measuring cell for hydrostatic level measurement. Cable version
- Process temperature: -10 up to +70°C (14 to +158°F), with FEP cable up to +80°C (176°F)
 - Measuring ranges: 0.1 to 10bar/100m H₂O (1.5 up to 150psi/300ft H₂O)
 - Reference accuracy: ±0.2%, "Platinum" ±0.1%

- 5**
Deltapilot S FMB70
Highest performance pressure sensor with the Contite measuring cell for hydrostatic level measurement. Compact version
- Process temperature: -10 up to +100°C (14 to +212°F), 135°C (275°F) for max. 30 minutes
 - Measuring ranges: 0.1 to 10bar rel. (1.5 up to 150psi)
 - Reference accuracy: ±0.1%, "Platinum" ±0.075%

Cerabar with diaphragm seals

If measurement is to take place under extreme conditions, a variety of diaphragm seals are available for the direct mounting or with capillary extension. They can be used for media temperatures from -70 up to 400°C (-94 to 752°F), are insensitive to aggressive, highly viscous, crystallizing or polymerizing media and are suitable for measuring points that are difficult to access. Our experts optimize the measuring systems to ensure the maximum degree of performance and reliability. The degree of variance and flexibility in membrane materials, process connections (e.g. extension tube) and connection type (e.g. compact, via temperature isolator or via capillary) allow a wide range of applications.

The free-of-charge software Applicator Sizing Diaphragm Seal allows an easy layout and optimization of diaphragm seal systems. Application limits and response times are shown as a function of temperature.

The patented TempC Membrane minimizes ambient and process temperature effects on the signal output.



The Cerabar portfolio for absolute, gauge and hydrostatic pressure with diaphragm seals



For selection and sizing of diaphragm seals, use www.endress.com/applicator

- 1**
Cerabar M PMP55
Digital pressure transmitter with fully welded diaphragm seal
- Process temperature:
 -70 up to $+400^{\circ}\text{C}$ (-94 up to $+752^{\circ}\text{F}$)
 - Measuring ranges:
 $-1/0$ up to $+400\text{bar}$ ($-15/0$ up to $+6000\text{psi}$)
 - Reference accuracy: $\pm 0.15\%$, "Platinum" $\pm 0.075\%$

- 2**
Cerabar S PMP75
Digital pressure transmitter with fully welded diaphragm seal
- Process temperature:
 -70 up to $+400^{\circ}\text{C}$ (-94 up to $+752^{\circ}\text{F}$)
 - Measuring ranges:
 $-1/0$ up to $+400\text{bar}$ ($-15/0$ to $+6000\text{psi}$)
 - Reference accuracy: $\pm 0.075\%$

✓ Advantages Cerabar M

- Very simple operation directly on the instrument or via the control system
- Aseptic connections and FDA-conforming materials
- Option of separate assembly from housing and electronic insert
- Modular electronics and displays
- User-friendly software with application-specific parameter selection

✓ Advantages Cerabar S

- Highest accuracy and long-term stability
- Reliable data management with HistoROM
- Easy operation with diagnosis functionality
- Two-chamber housing may be turned by 360° for an optimum view of the display
- Functional safety up to SIL 3
- Modular electronics, displays and sensors

Deltabar with silicon cell

The Deltabar differential pressure cell is used for flow measurements (volume or mass flow) in conjunction with Deltatop primary elements (orifice plates, pitot tubes, nozzles or venturies) for level, volume or mass measurements in liquids using impulse piping and for differential pressure monitoring applications such as filters and pumps.

The function-monitored measuring cell with high overpressure rating allows accurate measurement of small differential pressures in combination with high one-sided or two-sided static pressures.

Spare parts can be minimized as electronic inserts and the display are identical to the Cerabar and Deltapilot product family.



The Deltabar portfolio for differential pressure with silicon cell



- 1**
Deltabar M PMD55
Differential pressure transmitter with metal sensor for measurement of pressure differences
- Process temperature: -40 to +85°C (-40 to +185°F)
 - Measuring ranges: 0.5mbar to +40bar (0.0072 to +600psi)
 - Reference accuracy: ±0.1%, "Platinum" ±0.075%

- 2**
Deltabar S PMD75
Differential pressure transmitter with metal sensor for measurement of pressure differences
- Process temperature: -40 to +120°C (-40 to +248°F)
 - Measuring ranges: 0.25mbar to 40bar (0.0036 to 600psi)
 - Reference accuracy: ±0.05%, "Platinum" ±0.035%

- 3**
Deltabar with mounted manifold
- Delivered mounted with documented leakage test
 - Optional pressure tested

✓ Advantages Deltabar M

- Compact design
- Very simple operation directly on the instrument or via the control system
- Modular electronics and displays
- User-friendly software with application-specific parameter selection

✓ Advantages Deltabar S

- Highest accuracy and long-term stability
- Overload up to 420bar / 630bar on one or both sides
- Modular electronics, displays and sensors
- Reliable data management with HistoROM
- Extensive diagnosis functionality
- Functional safety up to SIL 3

Deltabar electronic dp with ceramic or silicon cell

Differential pressure measurement is often used to measure the level in pressurized and vacuum tanks. Traditional differential pressure measurement using impulse lines and capillaries have issues that can lead to less accuracy, process safety risks and greater total cost of ownership. This can be especially true in tall distillation towers or other vessels with varying ambient temperatures.

Eliminate typical mechanical issues of impulse lines like icing up, clogging, leaky tabs and dry/wet leg inconsistencies as well as temperature effects in capillary systems with the new electronic differential pressure system. Costs are also optimized as no system recalibration or reconfiguration are required with any component change, fewer spare parts are necessary, just one technician can install entire system and there is no need for freeze protection/heat tracing.



The Deltabar electronic dp portfolio for differential and hydrostatic pressure with silicon or ceramic cells



1

Electronic dp Deltabar FMD71

Electronic differential pressure system utilizing two ceramic sensor modules and one transmitter

- Process temperature: -25 to +150°C (-13 to +302°F)
- Measuring ranges: 100mbar to 40bar (1.5 to 600psi)
- Reference accuracy: Single sensor up to ±0.05%, system up to ±0.07%

2

Electronic dp Deltabar FMD72

Electronic differential pressure system utilizing two fully welded metal sensor modules and one transmitter

- Process temperature: -40 to +125°C (-40 to +257°F); with diaphragm seal up to +260°C (500°F)
- Measuring ranges: 400mbar to 40bar (6 to 600psi)
- Reference accuracy: Single sensor up to ±0.05%, system up to ±0.07%



Advantages Deltabar electronic dp

- The electronic differential pressure system eliminates traditional mechanical issues resulting in greater process availability and reliability
- Safety risks are minimized with the electronic differential pressure system architecture and design
- Lowest total cost of ownership due to reduced installation time, maintenance, downtime and spare requirements

Deltabar with diaphragm seals

Differential pressure transmitters with one or two diaphragm seals are most often used for level measurement in pressurised tanks with high static pressures and/or in applications where flush-mounted process connections are required. They can be used for media temperatures from -70 up to 400°C (-94 to 752°F), are insensitive to aggressive, highly viscous, crystallizing or polymerizing media. Our experts optimize the measuring systems to ensure the maximum degree of performance and reliability. The degree of variance and flexibility in membrane materials and process connections (e.g. extension tube) allow a wide range of applications.

The free-of-charge software Applicator Sizing Diaphragm Seal allows an easy layout and optimization of diaphragm seal systems. Application limits and response times are shown as a function of temperature.

The patented TempC Membrane minimizes ambient and process temperature effects on the signal output.



The Deltabar portfolio for differential and hydrostatic pressure with diaphragm seals



- 1**
Deltabar S FMD77
Differential pressure transmitter with one or two asymmetric diaphragm seals
- Process temperature: -70 to +400°C (-94 to +752°F)
 - Measuring ranges: 100mbar to 16bar (1.5 to 240psi)
 - Reference accuracy: ±0.075%

- 2**
Deltabar S FMD78
Differential pressure transmitter with two diaphragm seals for measurement of pressure differences and level
- Process temperature: -70 to +400°C (-94 to +752°F)
 - Measuring ranges: 100mbar to 16bar (1.5 to 240psi)
 - Reference accuracy: ±0.075%

✓ Advantages Deltabar S

- Volume optimized transmitter
- Reliable usage in harsh environmental conditions with coated capillaries
- Data management with HistoROM
- Functional safety up to SIL 3

Waterpilot with ceramic cell

Level measurement in deep wells is a typical application for the Waterpilot. Waterpilot – that means level measurement certified for drinking water with a robust ceramic sensor and integrated temperature measurement, all combined on a diameter of just 22mm (0.9"). As a result, the smallest of wells can be used for the application.

A robust design for applications in wastewaters and sludges or a design free of metal with long-term stability for usage in salt water is also available. Intelligent application solutions also means using the right accessories. The know-how behind many applications is invested in the extensive range of accessories to provide the optimal solution for your measuring tasks.



The Waterpilot portfolio for hydrostatic pressure with ceramic sensor

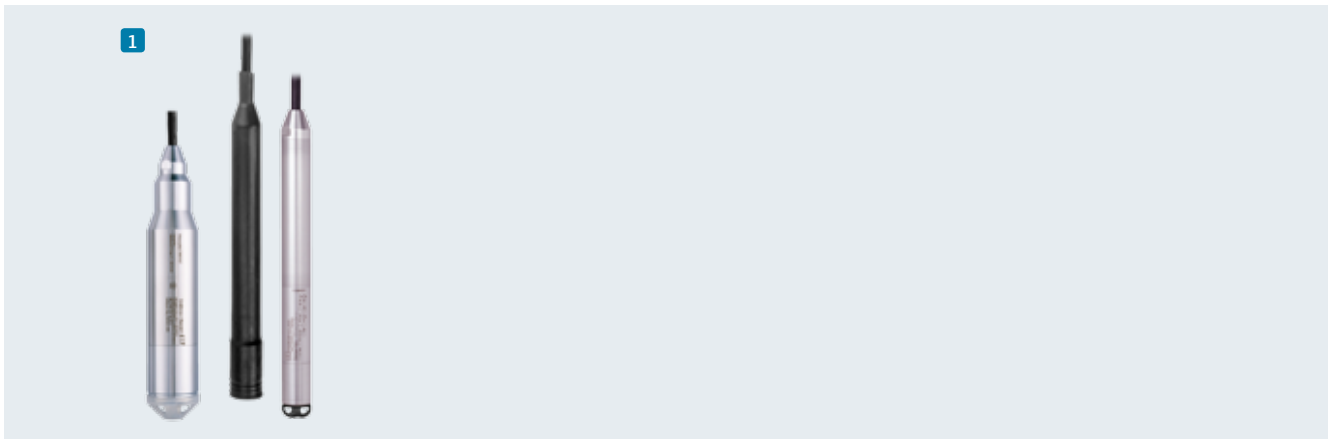

1

Waterpilot FMX21

Reliable and robust level probe with ceramic measuring cell and optional HART communication

- Process temperature:
 - 10 to +70°C (14 to +158°F)
- Measuring ranges: 0 to 20bar/200m H₂O
(0 to 300psi/600ft H₂O)
- Reference accuracy: ±0.2%, "Platinum" ±0.1%



Advantages Waterpilot

- Robust and abrasions-resistant ceramic cell
- Robust stainless steel housing with the smallest of probe diameters
- High resistance in case of overload as well as against aggressive media
- Integrated temperature sensor
- Materials in conformity with drinking water directives
- Extensive measuring point accessories
- Option: Level measurement with automatic density correction

Ceraphant pressure switch with ceramic or silicon cell

Over 30 years of knowledge and experience in pressure measurement have naturally left a mark in the development of Ceraphant, with the right amount of innovation at the right point, as in the hallmark of Endress+Hauser products. Ceraphant provides safe measurement and monitoring of absolute and gauge pressure in gas, steam and liquid.

The different process connection versions offer fast, easy and safe integration to the process. The Ceraphant is equipped with an illuminated display as standard. The measured values are visualized with the corresponding unit. Commissioning is sure and simple with operating keys. Pre-configured measuring ranges and switch points are also available.



The Ceraphant portfolio of absolute and gauge pressure switch



- 1**
Ceraphant PTC31B
Cost-effective pressure switch with oil-free ceramic sensor for measurement in gases or liquids
- Process temperature:
-25 to +100°C (-13 to +212°F)
 - Measuring ranges:
-1/0 up to +40bar (-15/0 up to +600psi)
 - Reference accuracy: ±0.5%/±0.3%

- 2**
Ceraphant PTP31B
Cost-effective pressure switch with fully welded metal sensor for measurement in gases, steam or liquids
- Process temperature:
-40 to +100°C (-40 to +212°F)
 - Measuring ranges:
-1/0 up to +400bar (-15/0 to +6,000psi)
 - Reference accuracy: ±0.5%/±0.3%

- 3**
Ceraphant PTP33B
Cost-effective pressure switch with fully welded metal sensor for use in hygienic applications
- Process temperature: -10 up to +100°C (14 to +212°F), 135°C (275°F) for max. 1h
 - Measuring ranges:
-1/0 up to +40bar (-15/0 to +600psi)
 - Reference accuracy: ±0.5%/±0.3%

✓ Advantages Ceraphant

- Quick and flexible process connection
- Function check and on-site information with LEDs and digital display
- Precise measuring / switching

Deltabar dp flow measurement

Deltabar transmitters can be combined with manifolds and a variety of primary elements for dp flow measurement. The layout can be optimized with the free-of-charge Applicator software.

 www.endress.com/applicator

Available primary elements include orifice plates, pitot tubes, venturis, wedge meters, v-cones, etc. Contact your Endress+Hauser inside sales team for product selection assistance.



Accessories

Tank spuds	Manifolds* DA63M	Shut-off valves* DA61V DA63M PZAV	Condensate pot DA61C	Orifice plates	Pitot tubes
					

Thanks to our comprehensive portfolio of accessories and assemblies in various materials and versions, your measuring point can be completely equipped. We are pleased to help you in designing your measuring point or use www.endress.com/applicator

* Also available mounted to Cerabar/Deltabar



Smooth integration into your control system – with digital communication

We offer all common electronic communication protocols. In addition to the classic analog electronics (output 4 to 20mA) digital electronic inserts are also available.

- FOUNDATION fieldbus offers easy testing of instruments, important additional information and diagnostic functionalities according to NAMUR NE107 as well as smooth system integration which increases the availability and safety of your plant.
- HART electronics (output 4 to 20mA with superimposed HART protocol) for additional functionalities and diagnostic functions according to NAMUR NE107.
- PROFIBUS PA electronics for the complete integration into digital industrial bus systems. Simplified instrument identification, brief uploading and downloading times during commissioning, diagnostic functionalities according to NAMUR NE107 and the smooth integration help to reduce costs and downtimes to a minimum.

All digital electronics may be smoothly integrated into different control systems and can be configured via a PC and the universal FieldCare/DeviceCare operating program as well as via all common PAM systems.

Integration of Endress+Hauser field devices into automation architectures

Control system

- ABB
- Emerson
- Honeywell
- Invensys
- Rockwell
- Schneider
- Siemens
- Yokogawa

Process management

Control system

Plant Asset Management (PAM)

HART

PROFIBUS



Endress+Hauser field devices

Plant Asset Management





- ABB
- Endress+Hauser
- Emerson
- Honeywell
- Invensys
- Metso Automation
- PACTware
- Siemens
- Yokogawa

The integration capability of the instruments is tested at our system laboratory thus ensuring their system independence. We also offer training opportunities directed especially to the integration of instruments into respective control systems.



Operating cost savings due to instrument diagnosis

Plant asset management is one of the most important trends in process industry. Thanks to digital communication protocols, all current Endress+Hauser instruments support the diagnostic categories according to NAMUR NE107. The pertaining classification of failures into four categories ensures that the right information is transmitted to the right persons at the right time. This avoids operating failures, improves the maintenance cycle and finally reduces costs.

Diagnostic categories		
Symbol	Status Text	Explanation
	Failure	The output signal is invalid due to a functional failure in the field instrument or its periphery.
	Function control	Work is performed on the field instrument, the output signal is thus temporarily invalid (e.g. frozen).
	Maintenance requirement	The output signal is still valid but the wear and tear reserve will be depleted soon or a function will be limited shortly due to the conditions of use, e.g. ageing of the pH electrode.
	Non-conformance to specification	Deviations from the permitted ambient or process conditions determined by the instrument through self-monitoring or failures in the instrument itself show that the uncertainty of measurement in sensors or set point deviation in actuators probably exceeds what is expected under operational conditions.

The correct use of diagnostic information can save operating costs in specific applications. Our pressure instrumentation delivers critical diagnostic information which can be easily managed via a plant asset management system.

- The analysis of pressure and temperature surges in a process permits conclusions of a shortened useful life of the instrument or a problem in the process.
- A user-specific pressure and temperature range (operating window) can be determined. If the same is underrun or surpassed, a diagnostic message can be issued.

Numerous further possibilities are available in the pressure instrumentation operating instructions.



Calibration

Calibration laboratory

Measuring correctly is the 'metrological basis' for any manufacturer of measuring instrumentation. Those wanting to produce to ISO 9000 standards must be able to rely on dependable calibration equipment for all measuring devices.

Endress+Hauser's own calibration was established in 1994.

It is responsible for managing the company's test equipment and looks after some thousand measuring units used in production, development and service. Devices are calibrated for our own use, for clients and for third-party customers.

This guarantees that measurements on products can be safely traced back to 'national calibration standards'.

The calibration laboratory is accredited as a DAkkS (national accreditation body for the Federal Republic of Germany) lab (D-K-15172-01-00) for the measured variables vacuum and pressure. Pressure ranges from 1µbar (1.45 x 10⁻⁵psi), absolute pressure to 500bar (7,252psi) and from -1bar (-14.5psi) gauge pressure to 500bar (7,252psi). The smallest uncertainty of measurement which may be passed on is 0.003%.

Fully automated DKD/DAkkS calibration in the production process

Since 2004 automated DKD/DAkkS calibration is integrated in the running production process.

This ensures fast delivery times and traceable calibration.

You have the possibility of selecting DKD/DAkkS calibration directly via

the order code when ordering a pressure device.

This means fully automatic control of the entire test procedure – right up to printing of test certificates and labels in the packaging unit.



Test Center

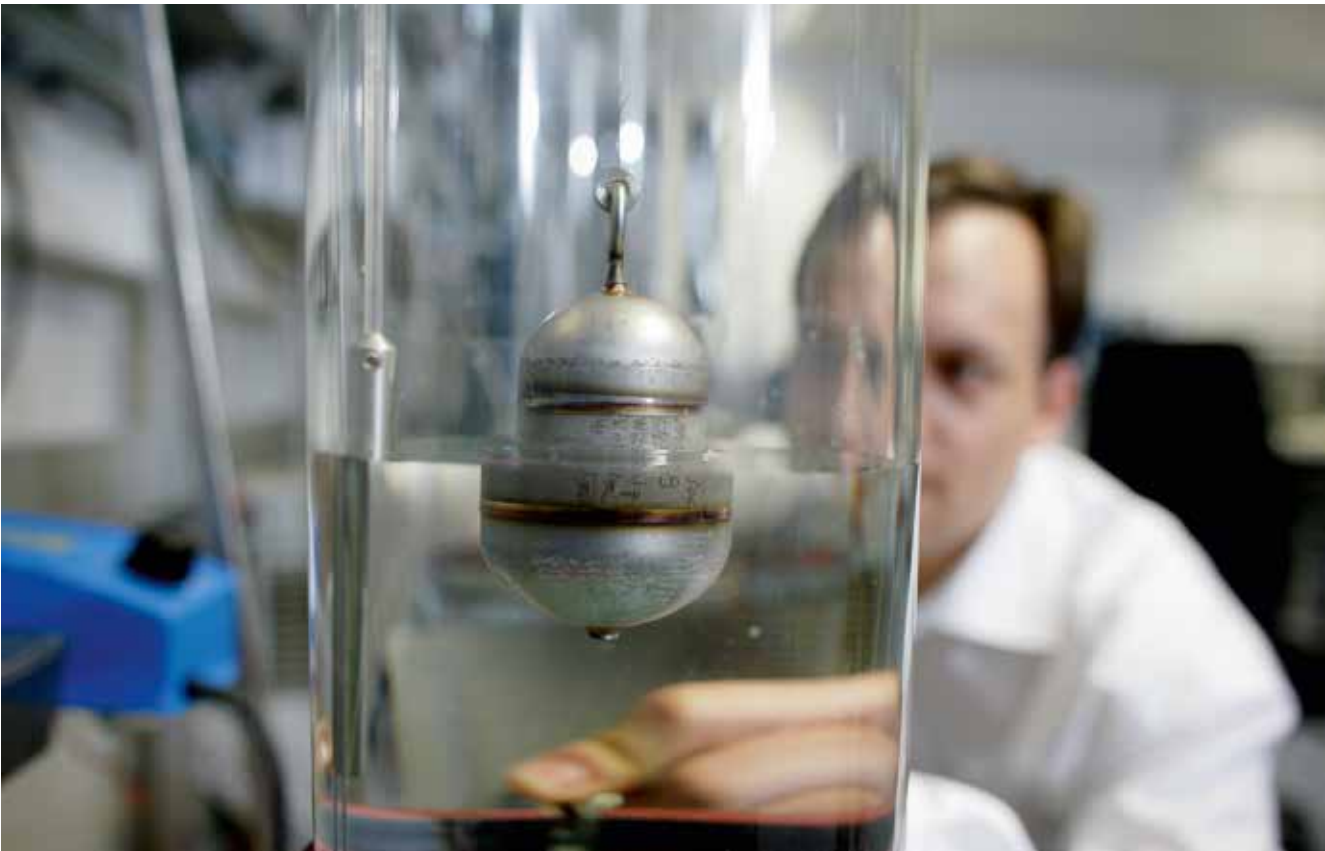

There are some things you can never get enough of – for example, safety

Our Test Center (internationally accredited test centre: FM, CSA) has three laboratories for device safety, application technology and electromagnetic compatibility. The various test units make it possible to ensure and improve the reliability and quality of our devices under realistic test conditions. In addition, the devices for new applications can be tested in advance during development. In the various 'durability tests', devices are exposed to extreme conditions as can be expected in real applications.

These include dust tests (explosion protection), abrasion and friction tests, climate tests (heat and cold), mechanical load tests and spray water leak tests. A fully automated tank test plant with a capacity of 24,000 liter, is used to simulate the most difficult applications. The Test Center also has an accredited EMC laboratory.

Apart from carrying out tests on our devices during development, the Test Center also trains service staff and even customers. Customer specific

application problems are analyzed, tests to simulate new applications are run and device approvals are carried out.



Tools for selection and sizing

Endress+Hauser Applicator

Our Applicator software is a convenient selection and sizing tool for planning processes. Using the entered application parameters, e.g. from measuring point specifications, Applicator determines a selection of suitable products and solutions.

Applicator includes modules for dp flow, electronic dp and diaphragm seals.

Optimizing dp flow measuring point:

- Up- and downstream length
- Pressure loss
- Dynamic flow range

Optimizing diaphragm seal systems:

- Minimizing temperature effects for max. performance
- Membrane deflection under operating conditions for maximum reliability



www.endress.com/applicator

Endress+Hauser Operations App

The app offers fast access to up-to-date product information and device details e.g. order code, availability, spare parts, successor products for old devices and general product information - wherever you are, whenever you need it.

Simply enter the serial number or scan the data matrix code on the device to download the information.



Available on the
App Store



Scan the QR-Code





Services - by your side

Committed to your business, for improved plant performance

Our commitment to you is to support, to service and to optimize your process. Whatever your location or your industry, our global service force of over 1000 experts is strategically located worldwide ensuring active local presence to help you reach your goals. Based on our process knowledge and technical expertise, a uniform approach through clear procedures ensures that the work we conduct for you is done properly. Customized responses can also be adapted to your needs, contact us today.

Supporting

Need quick response to support you in emergency situations? We are near you – ready and willing to provide you with the appropriate support

- Diagnostic and repair
- Support services

Servicing

Looking for expertise? We offer a variety of services to complement the capabilities of your staff throughout your plant lifecycle

- Calibration services
- Commissioning services
- Maintenance services
- Training and seminars
- Engineering services

Optimizing

Need help to reduce costs while maintaining compliance? We offer effective ways to optimize your processes, enabling you to increase productivity and reach your business goals

- Maintenance optimization

www.addresses.endress.com

FA00004F/24/EN/22.17