

Temperature measurement

Thermometers and transmitters for the process industry



Temperature measurement



Endress+Hauser – Your partner

Endress+Hauser is a global leader in measurement instrumentation, services and solutions for industrial process engineering

With dedicated sales centers and a strong network of partners, Endress+Hauser guarantees competent worldwide support. Our production centers in twelve countries meet your needs and requirements quickly and effectively. The Group is managed and coordinated by a holding company in Reinach, Switzerland. As a successful family-owned business, Endress+Hauser is set to remain independent and self-reliant.

Endress+Hauser provides sensors, instruments, systems and services for level, flow, pressure and temperature measurement as well as analytics and data acquisition. The company supports you with automation engineering, logistics and IT services and solutions. Our products set standards in quality and technology.

We work closely with the chemical, petrochemical, food and beverage, oil and gas, water and wastewater, power and energy, life science, primary and metal, renewable energy, pulp and paper and shipbuilding industries. Endress+Hauser helps customers to optimize their processes in terms of reliability, safety, economic efficiency and environmental impact.



E-direct - Purchase preconfigured basic field instruments or system components easily.
www.e-direct.endress.com



To learn more about Endress+Hauser, visit:
www.endress.com

Competence center for temperature measurement, temperature engineered solutions and system products

Endress+Hauser Temperature+System Products is one of the leading producers of temperature measurement, temperature engineered solutions and system products worldwide.

The company employs more than 630 associates worldwide. 360 of which are working in our headquarters Nesselwang (Germany), where our products are developed and produced.

Associated Product Centers in Pessano (Italy), Greenwood (USA), Suzhou (China) and Aurangabad (India) guarantee customer proximity with products and services.





Temperature measurement by Endress+Hauser – Because we understand

4	Overview of industries	34	Compact versions	50	High-temperature thermometers
4	Oil and gas	36	iTHERM TrustSens		
6	Chemicals	38	iTHERM ModuLine	52	Engineered temperature solutions
8	Primaries and metal	38	Thermometers with metric design		
10	Food and beverage	40	Selection guide		
12	Life sciences	42	iTHERM ModuLine		
14	Water and wastewater			54	Test center
16	Power and energy				
18	Product overview	44	Thermometers with barstock thermowell	55	Calibration and certificates
20	Thermometer design			56	Planning, commissioning & maintenance
20	Basic design of modular thermometer	46	Modular, hygienic thermometers		
21	Inserts	48	Next Level Hygienic instruments		
23	Thermowells				
26	Sensor technology				
28	Process connections				
29	Terminal heads				
30	Transmitters				

Its expansive, globally available portfolio of standard thermometers, temperature transmitters and engineered solutions makes Endress+Hauser one of the leading international complete providers of temperature measuring technology for process automation. The large vertical range of production and the high degree of in-house development, ranging from primary sensors and electronics to customized special solutions, make a crucial difference here. As a reliable and close partner for our customers, we utilize our wealth of product and solution expertise to develop innovative products that produce excellent customer benefits. These products include the world's first self-calibrating thermometer iTHERM TrustSens and unique inserts such as the iTHERM QuickSens and StrongSens, excellent temperature transmitters like the iTEMP TMT162 - SIL2/3 and even multi-point solutions for 2D/3D measurements in digesters. As your expert partner in all issues related to temperature measuring technology, we make a crucial contribution to making your processes more reliable and efficient and increasing the quality of the end products.



Fuel for thought

With vast experience in the oil & gas sector, we help you to perform, comply and thrive

From exploration to refinery, from storage to distribution, from plant upgrades to new projects, we have the application expertise to help you succeed.

At a time when the sector faces skills shortages and regulations tightening, our organization is here across the full life cycle of your project always with your deadlines in mind. While complexity of facilities and processes are ever increasing, and downtime must be reduced, your competitiveness is enhanced with reliable, accurate and traceable asset information.

In short, you need to do more with less, benefiting from a stable partner who is here for the long haul and ready across the globe, offering:

- Assured plant safety
- Optimized return on investment
- Best-fit products, solutions and services

✓ Advantages at a glance

- Mitigating risks by using state of the art technology meeting highest demands with regard to Functional Safety (IEC 61508) and mechanical integrity (e.g. gastight feedthrough)
- Minimizing operational costs through efficient proof testing concepts, predictive maintenance and innovative data management
- Meeting internationally recognized standards and recommendations such as: API, OIML, ASME, NORSOK, NACE etc.
- Increasing plant availability with innovative technologies particularly designed for oil and gas industry applications

Product Highlights



iTEMP TMT72, TMT82, TMT162; TMT142

The right HART transmitter for every application

- SIL 2/3-certified in accordance with IEC61508:2010
- HART 7 version for quick data exchange and with extended diagnostic functions
- Optionally available with integrated overvoltage protection to protect the electronic components in the transmitter
- As a head transmitter, top-hat rail device or in the field housing
- Fast and tool-free wiring using spring terminal technology



TR66 / TC66

Resistance thermometers (RTD) or thermocouples for heavy-duty applications

- Barstock thermowell in line with the ASME standard for high process pressures, temperatures and flow velocities.
- Flexibility through optionally installed head transmitters with various communication types 4...20 mA, HART, PROFIBUS PA or FOUNDATION Fieldbus
- Special resistance thermometers (RTD) or thermocouples for various applications



TT511 / TT151 thermowell

TT511 Drilled barstock thermowell with slip-on flange TT151 Drilled barstock thermowell for weld in, threaded or flanged process connection

- Design specifically created for the oil & gas and petrochemical industries meets the highest requirements
- Flexible application options in conjunction with RTD or TC thermometers
- Reliable plant operation due to load capacity calculations for the thermowell in accordance with DIN43772 or ASME PTC19.3 TW2010



T13 / T53

Resistance thermometers (RTD) or thermocouples for heavy-duty applications

- Barstock thermowell in line with the ASME standard for high process pressures, temperatures and flow velocities.
- Flexibility through optionally installed head transmitters with various communication types
- Approvals for potentially explosive atmospheres in accordance with CSA and FM
- Vibration resistance of the measuring element up to 60g



iTHERM StrongSens

Highly vibration-resistant RTD insert

- Available in many RTD thermometers
- Vibration resistance of the measuring element up to 60g
- Also suitable for applications in hazardous areas



iTHERM Moduline TM131

Thermometers with RTD or TC insert, can be configured for a variety of applications

- Suitable for the most stringent safety requirements due to second process barrier
- Head transmitter with various communication types
- Approvals for hazardous areas as per ATEX, IEC, NEPSI and CSA C US
- Fast-response inserts, measuring element vibration-resistant up to 60g



iTHERM MultiSens Flex TMS0x / MultiSens Linear TMS0x

Linear and three-dimensional Multipoint RTD or TC thermometers

- Flexible design especially developed for the requirements of the oil & gas and petrochemical industries
- Monitoring of a large number of temperature measuring points
- Diagnostic chamber as secondary process barrier for improved process safety

Further customer-specific temperature engineered solutions

- Surface temperature measurement with SkinPoint thermometer
- High-precision multipoint thermometers for measuring the average and local temperature in silos and storage applications



Global chemicals, competitive and safe

Get the extra project skill and know-how you need to boost your plant's safe performance

You gain concrete benefits from a partner who has first-hand knowledge of your sector's issues around the globe: on increased safety, on environmental protection, on over-supply leading to cost pressure and on finding engineering support and service when required. You can rely on our help to become more competitive in your line of business.

With a long history of industry firsts we have grown with the sector by listening, acting and innovating to better serve you with:

- Safety, built in
- The technology to lead
- Best-fit project management

✓ Advantages at a glance

- Meeting internationally recognized standards/ recommendations: NAMUR, WHG, ASME, NACE, IEC 17025, MID, OIML
- Internationally accepted hazardous area approvals: ATEX, IECEx, FM/CSA, NEPSI, TIIS, INMETRO
- Use of state of the art technology – functional safety according to IEC 61508 (up to SIL 3)
- Uniform operating safety by design concepts for simple and safe operations
- Optimized material availability and minimized stocks through inventory management solutions

Product Highlights



iTHERM ModuLine TM131

Thermometers with RTD or TC insert

- Flexible configuration for a variety of applications
- Fastest response times even with thermowell
- Suitable for the most stringent safety requirements due to second process barrier



TR15 / TC15

Robust temperature measuring technology, ideal for steam or gas applications

- For high process pressures and temperatures in demanding applications
- Fast response times with reduced/tapered thermowell tip
- Head transmitter with simple communication type selection



iTHERM MultiSens Slim TMS21

Minimally invasive, wetted multipoint thermometer

- Adaptable customer-specific design (dimensions, material, linear or flexible)
- Monitoring of a large number of temperature measuring points
- Simple installation thanks to only one process connection



TH13 / TH14 / T14

Best-in-class temperature measuring technology in US design

- High flexibility through modular assembly
- Robust design for extremely harsh ambient conditions



iTEMP TMT72, TMT82, TMT162

The right HART transmitter for every application

- SIL 2/3-certified in accordance with IEC61508:2010
- HART 7 version for quick data exchange and with extended diagnostic functions
- Optionally available with integrated overvoltage protection to protect the electronic components in the transmitter
- As a head transmitter, top-hat rail device or in the field housing
- Fast and tool-free wiring using spring terminal technology



Thermowells TT151, TT131

For heavy duty applications: TT151 drilled barstock thermowell

For medium duty applications: TT131 welded thermowell

- Weld-in, threads or flanges
- Flexible application options in conjunction with RTD or TC thermometers
- Reliable plant operation due to load capacity calculations for the thermowell in accordance with DIN43772 or ASME PTC19.3 TW2010

Temperature measurement for critical applications

The most important parameter for ensuring safe operation of a turbine is to measure the temperature of the superheated steam at its inlet. An incorrect signal, triggered by a faulty temperature sensor, and the safety PLC can cause the complete system to switch over to emergency mode. This causes the boiler and turbine to restart, which wastes time and money. The iTEMP TMT82 and TMT162 temperature transmitters are certified by TÜV for SIL 2/3 applications in accordance with IEC61508:2010 and can solve this problem.

To ensure maximum availability and reliability, the devices are equipped with two inputs for temperature sensors, enabling operation with redundant sensors. If one of the two temperature sensors returns a faulty signal, the system automatically switches to the backup sensor and a diagnostic message is sent via HART. This notifies the control room of the sensor failure. On the other hand, the 4...20 mA output continues to return a valid measured value, which ensures uninterrupted operation of the system.



Extracting more from less

In a world of lower grades, skills gaps and excavation challenges - we can help you hit your targets

We've seen how lower grades are driving an acute need for ever-better automation and controls. You are also facing emerging skills gap, requiring better-informed industry partners. At the same time, energy costs are only going one way, and the legislative environment is becoming increasingly stringent.

Tough challenges call for experienced heads who can:

- Reduce your metal and mineral production costs
- Keep your plant safe
- Boost compliance and responsibility

✔ Advantages at a glance

- Complete product basket for all applications, specifically in harsh environments
- Advanced diagnostic functionalities to make the process more safe and reliable
- Savings in raw material, water, energy and labor through accurate data of critical and quality relevant points in your process

Product Highlights



TR15 / TC15

Robust temperature measuring technology, ideal for steam or gas applications

- For high process pressures and temperatures in demanding applications
- Fast response times with reduced/ tapered thermowell tip
- Head transmitter with simple communication type selection
- Suitable for use in hazardous areas



TAF11 / TAF12S/D/T / TAF16

Modular high temperature thermometers

- Robust design due to multiple ceramic or metallic thermowells
- Selection of high-temperature thermocouples
- Selection of durable thermowell materials that offer greater resistance to wear and chemicals
- Flexible product selection thanks to modular design
- Replaceable spare parts optimize life cycle costs



iTEMP TMT71/72

HART / 4...20mA temperature transmitter

- Maximum reliability, availability and accuracy
- Bluetooth® configuration
- Fast and tool-free wiring using spring terminal technology
- As a head transmitter, DIN rail device or in the field housing



iTHERM Moduline TM131

Thermometers with RTD or TC insert

- Can be configured for a variety of applications
- Suitable for the most stringent safety requirements due to second process barrier
- Fastest response times even with thermowell
- Head transmitter with selection of communication types
- Suitable for use in hazardous areas

Rotary kiln in the tile manufacturing

The clay manufacturing application in the rotary kiln for tile production requires a specially adapted TAF16. A thermowell made of a nickel/cobalt alloy, which features high wear and corrosion resistance at high temperatures, is used to protect the sensor. A wireless HART module ensures reliable signal transmission from the rotary kiln to the control room. Special reflective discs are installed between the process connection and terminal head to protect the electronics from overheating due to strong heat emission.

This allows the thermometer to be used optimally in various sections of the kiln, from the drying area at 300 °C to the combustion area with temperatures up to 1000 °C.

Your benefit: This method can be used to double the operating times of the sensors in this process.

- Easy data transfer using a wireless HART module SWA70
- Reduced heat emission using suitable reflective discs
- Suitable thermowell materials for high resistance to erosion and corrosion





Nourishing your productivity

Your global partner for accurate measurements and expert support in food and beverages automation

From hygiene regulations and food safety to the basic demands of reliability and uptime, high quality food & beverage producers profit from our experience in more than 100 countries.

Get it right the first time and make your safe choice:

- Constant food quality & compliance
- Resources savings
- An expert partner

✓ Advantages at a glance

- The world's first self-calibrating thermometer reduces process risks and costs
- Other modular, accurate, safe and reliable hygienic thermometers which enable quick recalibration thanks to iTHERM QuickNeck technology
- Best-in-class hygienic design
- Innovative thermowells with optimum hygienic properties

Product Highlights



iTHERM TM411 / TM412

Forward-looking, hygienic thermometer with modular design

- Maximum possible variability for any demands
- Groundbreaking technologies for extremely easy handling, maximum process reliability and efficiency



iTHERM TM401 / TM402 (E-direct)

Hygienic, modular thermometer - Basic technology

- Developed specifically for use in hygienic and aseptic applications
- Best cost/performance ratio and fast delivery time



iTHERM CompactLine TM311 / TMR35 (E-direct)

Hygienic compact thermometer

- Compact, fast and precise
- Ideal for short immersion depths when installing in areas with small nominal pipe diameters



iTHERM TrustSens TM371 / TM372

World's first self-calibrating thermometer

- Minimizes risks and costs
- 100% compliance and audit-proof documentation
- No undetected failures



iTHERM QuickSens

Shortest response times worldwide:

- Fast, high-precision measurements
- Minimization of the needed immersion length
- Use of thermowells without affecting the measuring performance



iTEMP TMT180 / TMT181

HART / 4...20 mA temperature head transmitters

- Best cost/performance ratio
- High accuracy
- Bluetooth® configuration

Heating processes

A frequently used heating process for preserving milk is called (flash) pasteurization (high-temperature short-time HTST processing).

Heating is used to neutralize any dangerous microorganisms that may be in raw milk. As a result, this is one of the most critical processes in terms of food safety.

Exact compliance with temperature specifications is mandatory in guaranteeing the effectiveness of this process. Excessive temperatures should be avoided due to their effects on taste and energy consumption. However, specialists must also ensure that the temperature in the holder tube never drops below the specified minimum temperature.

This can be ensured by implementing fast, tight temperature control which, in turn, is based on the fastest possible recording of temperature fluctuations. Endress+Hauser provides the critical advantage with iTHERM QuickSens technology sensors, which are the fastest in the world. Additionally, iTHERM QuickNeck – a divisible neck tube with a quick-release fastener – enables fast, tool-free calibration on site. These technologies are examples of product innovations from the iTHERM TM411 thermometer series, which sets new benchmarks for hygienic applications.





The pulse of life sciences

Trust a reliable partner who puts quality, compliance and cost control at the heart of life sciences

It is a daily task to meet stringent GxP regulations and productivity goals throughout your product lifecycle. You can count on our world-class instruments, designed to ASME-BPE standards, but also our highly qualified engineering input and experienced service teams. We partner with you to generate process optimization, higher plant availability and continuous improvement.

Our excellence, gained at the heart of the sector, will help you to:

- Streamline your projects
- Attain operational experience
- Make the right decisions

✓ Advantages at a glance

- The world's first self-calibrating thermometer reduces process risks and costs
- Other modular, accurate, safe and reliable hygienic thermometers which enable quick recalibration thanks to iTHERM QuickNeck technology
- Best-in-class hygienic design
- Innovative thermowells with optimum hygienic properties

Product Highlights



iTHERM TM411 / TM412

Forward-looking, hygienic thermometer with modular design

- Maximum possible variability for any demands
- Groundbreaking technologies for extremely easy handling, maximum process reliability and efficiency



iTHERM TrustSens TM371 / TM372

World's first self-calibrating thermometer

- Minimizes risks and costs
- 100% compliance and audit-proof documentation
- No undetected failures



iTHERM TM401 / TM402 (E-direct)

Hygienic, modular thermometer - Basic technology

- Developed specifically for use in hygienic and aseptic applications
- Best cost/performance ratio and fast delivery time



iTEMP TMT82

HART 7 temperature transmitter

- Maximum reliability and availability
- Maximum accuracy due to sensor-transmitter matching
- 2 sensor inputs



iTHERM CompactLine TM311 / TMR35 (E-direct)

Hygienic compact thermometer

- Compact, fast and precise
- Ideal for short immersion depths when installing in areas with small nominal pipe diameters



iTHERM TT4xx

Innovative thermowell design for hygienic applications

- High-precision measurement thanks to optimized design
- Increased process safety and reliability due to assembly without welding seams and without dead spaces
- Numerous different pipe sizes available as standard

iTHERM QuickSens measuring insert

In the pharmaceutical industry, some of the plants are used for very small nominal pipe diameters. This makes the temperature measurement special challenges. Otherwise usual, hygienic process adaptations are only possible from a certain minimum nominal diameter can be used. Endress+Hauser therefore offers welding solutions as T- or elbow pieces with integrated protection tube for hygienic integration of temperature measuring points in small pipelines.

Due to these small nominal widths, the sensor technology needs to cover special requirements. The position of the actual sensor element 10...15 mm for standard measuring inserts behind the top. A considerable measuring error occurs for very small immersion lengths, as the sensor here is based on the height of the pipe wall instead of in the middle of the pipe.

Endress+Hauser has developed a special solution to this problem - the iTHERM QuickSens measuring insert. It is a special sensor design, in which the primary sensor is directly soldered on the measuring insert tip. This enables up to 7-fold shorter immersion lengths and the world's shortest response times.

With the iTHERM TM411 thermometer, Endress+Hauser offers the following benefits an innovative cutting-edge technology. This guarantees user the highest possible accuracy, process control and safety as well as quality without compromise.





Water is our life

Water quality, discharges, regulations, the environment... just rely on a trusted partner

As budgets shrink and legislative demands soar, we bring expertise for challenging needs. Safe potable water... discharges, environmental penalties... water infrastructure for developing countries... energy monitoring... the rising quantities of sludge from wastewater treatment and the opportunities they create for biogas. We make sense of it all, with experienced thinking supported by process technology solutions for your every need.

Through working with water in over 100 countries, Endress+Hauser offers a refreshing alternative.

- Improve plant safety and availability
- Optimize costs in your internal water processes
- Support your risk and failure management



Advantages at a glance

- Cost-effective product and service portfolio for any applications, e.g. for drinking water, wastewater and sewage, desalination
- Meeting internationally recognized standards/ recommendations for drinking water applications
- Highest efficiency by easy commissioning, operation and maintenance of instruments

Product Highlights



iTHERM ModuLine: TM101, TM111, TM121, TM131

Assorted thermometers with RTD or TC insert

Flexible configuration for a variety of different applications ranging from straightforward monitoring tasks to complex, safety-related measuring points



iTHERM CompactLine TM311 / TMR31 (E-direct)

Compact thermometer for industrial processes

- Compact, fast and precise
- Best cost/performance ratio and fast delivery time



TST434

Modular thermometer for inside/outside temperature measurement

- Robust terminal heads in accordance with DIN EN 50446 or stable plastic housings
- Easy and fast wall mounting
- Reliable temperature measurement with long-term stability



iTEMP TMT71

4...20 mA temperature head transmitters

- Best cost/performance ratio
- High accuracy
- Bluetooth® configuration



TH13

Best-in-class temperature measuring technology in US design

- High flexibility through modular assembly
- Robust design for extremely harsh ambient conditions



iTEMP TMT72

HART / 4...20 mA temperature head transmitters

- Best cost/performance ratio
- High accuracy
- Bluetooth® configuration
- HART 7 version for quick data exchange and with extended diagnostic functions

Operate your digester safely and reliably

Reduce operating costs and optimize the energy balance. In sewage management, a strong trend toward sludge treatment can be seen worldwide. This can primarily be ascribed to more stringent local requirements, which prohibit introducing sewage sludge into the environment (bodies of water, fields). As a result, sewage sludge has become a considerable cost factor for plant operators. In these scenarios, sludge decomposition can provide a cost advantage because it can be used to reduce the amount of sludge by around 50% and is also a valuable energy source for biogas.

Anaerobic bacteria require stable process conditions

The bacteria has to be protected from critical process conditions while processes take place in the digester. It is crucial to maintain a constant temperature. Endress+Hauser provides a reliable, robust thermometer for precisely this purpose – the Omnigrad M TR10. A thermowell with a reduced/tapered tip guarantees fast, immediate responses to changes in temperature. An optional head transmitter with all common communication protocols increases measuring accuracy and reliability compared to directly wired sensors.





Power up your plant

Power plants play a vital role. We help minimize downtime whilst delivering safety and productivity

Your plant needs a multi-skilled, versatile partner. You need reliable solutions that meet your application requirements and industry quality standards. And you may need to upgrade ageing plants with proven and state-of-the-art technologies, to keep the output consistently high.

As the industry shifts towards natural gas, renewables and the new market dynamics driven by shale gas, our mission is to provide the all-round support and experience you need. This includes elevated standards of safety for your staff. And the ability to meet even-higher environmental demands in flue gas cleaning processes such as SCR catalysts for nitrogen oxide reduction, electrostatic precipitators (ESPs) for particle separation, and limestone scrubbing processes for desulphurization.

When you choose us, you:

- Boost the efficiency of your plant
- Heighten safety
- Maintain expertise

✓ Advantages at a glance

- Functional safety: IEC 61508 SIL 2/3 certified
- Intelligent instruments with continuous self-monitoring
- Minimized downtime and highest safety through modern instrumentation

Product Highlights



HART TMT72, TMT82, TMT162; TMT142

The right HART transmitter for every application

- SIL 2/3-certified in accordance with IEC61508:2010
- HART 7 version for quick data exchange and with extended diagnostic functions
- Optionally available with integrated overvoltage protection to protect the electronic components in the transmitter
- As a head transmitter, top-hat rail device or in the field housing
- Fast and tool-free wiring using spring terminal technology



TR15 / TC15

Robust temperature measuring technology, ideal for steam or gas applications

- For high process pressures and temperatures in demanding applications
- Fast response times with reduced/ tapered thermowell tip
- Flexibility through optionally installed head transmitters with various communication types



iTHERM ModuLine: TM111, TM131

Assorted thermometers with RTD or TC insert

- Flexible configuration for a variety of different applications ranging from straightforward monitoring tasks to complex, safety-related measuring points
- Fastest response times even with thermowell



iTHERM StrongSens

Highly vibration-resistant RTD insert

- Available in many RTD thermometers
- Vibration resistance of the measuring element >60g
- Also suitable applications in hazardous areas



TST310 / TSC310

Cable thermometer for direct installation

- Robust design, flexible configuration
- RTD or TC elements
- Mineral-insulated stainless steel or nickel-based sheathed cable
- Also suitable applications in hazardous areas



Thermowells TT151, TT131

For heavy duty applications: TT151 drilled barstock thermowell

For medium duty applications: TT131 welded thermowell

- Weld-in, threads or flanges
- Flexible application options in conjunction with RTD or TC thermometers
- Reliable plant operation due to load capacity calculations for the thermowell in accordance with DIN43772 or ASME PTC19.3 TW2010



TAF11 / TAF12S/D/T / TAF16

Modular high-temperature thermometer

- Robust design due to multiple ceramic thermowells or metallic thermowells
- Selection of high-temperature thermocouples
- Selection of durable thermowell materials

Temperature measurement on the feed water pump





At temperatures of approximately 170 °C and a pressure of approximately 220 bar, the temperature measurement on the feed water pump is not a particularly demanding measurement.

However, the temperature sensor is subjected to strong vibrations and often has a short operating life as a result. Using a thermometer with a barstock thermowell in conjunction with a vibration-resistant iTHERM StrongSens insert leads to a durable solution. The sensor's fast response time and the excellent long-term stability contribute to reliable process control and short downtimes.







Thermometer product overview

Endress+Hauser offers a complete assortment of compact thermometers, modular thermometers, thermowells, measurement inserts and accessories for all types of process industries.

Product group	Cable sensor	Compact thermometer	iTHERM ModuLine	Modular, heavy-duty, with barstock thermowell
Design				
Description	Cable sensor	Compact thermometer, self-calibrating thermometer, temperature switch	Modular thermometers for a wide range of industrial applications	Modular thermometer with barstock thermowell for high process pressures and high flow velocities
Application/sector	Universal	Universal, food & pharmaceutical	Universal, chemicals, energy, oil and gas	Universal, oil & gas, chemicals
Approval/certificates	ATEX Ex i, ATEX Ex nA, IECEx Ga Ex ia NEPSI Ex ia	EHEDG, 3-A, FDA, ASME BPE	ATEX: Ex nA, Ex tb, Ex ia, Ex d IECEX: Ex tb, Ex d, Ex ia NEPSI: Ex ia, Ex tb, Ex nA, Ex d EAC: Ex ia, Ex d CSA C/US: IS, XP, DIP, GP	ATEX: Ex nA, Ex ia, Ex d IECEX: Ex tD, Ex d, Ex ia NEPSI: Ex ia, Ex nA, Ex d EAC: Ex ia, Ex d
Measuring ranges	RTD: -50 to +400 °C (-58 to +752 °F) TC: -40 to +1100 °C (-40 to +2012 °F)	RTD: -50 to +200 °C (-58 to +392 °F)	RTD: -200 to +600 °C (-328 to +1112 °F) TC: -40 to +1100 °C (-40 to +2012 °F)	RTD: -200 to +600 °C (-328 to +1112 °F) TC: -40 to +1100 °C (-40 to +2012 °F)
Process connection	For insertion, compression fittings, thread	Hygienic process connections and weld-in connections	For insertion, compression fittings, thread, flanges, weld-in connections	Thread, flanges, weld-in connections



Modular, hygienic	High temperature	Temperature engineered solutions
 		 
<p>Modular thermometers with hygienic process connections</p>	<p>High temperature thermometers with metallic/ceramic thermowell and thermocouples</p>	<p>SkinPoint thermometers for incinerators, multipoint thermometers, application-specific solutions</p>
<p>Food & pharmaceuticals</p>	<p>Energy, primaries industry, metal processing, flue gas</p>	<p>Oil and gas, energy, chemicals</p>
<p>ATEX: Ex nA, Ex tb, Ex ia IECEX: Ex tb, Ex ia NEPSI: Ex ia, Ex nA CSA C/US: NI, GP, IS FM: NI, IS EHEDG, 3-A, FDA, ASME BPE</p>	<p>-</p>	<p>PED, CRN; ATEX Ex d; FM/CSA: XP</p>
<p>RTD: -200 to +600 °C (-328 to +1112 °F)</p>	<p>TC: 0 to +1800 °C (32 to +3272 °F)</p>	<p>RTD: -200 to +600 °C (-328 to +1112 °F) TC: -200 to +1700 °C (-328 to +3092 °F)</p>
<p>Practically all common hygienic process connections and weld-in connections</p>	<p>Flanges, gas-tight threaded couplings</p>	<p>Customer-specific solutions</p>



Basic design of modular thermometer

The mechanical construction of a thermometer used in process plants is the same for resistance thermometers and thermocouples and consists of the following components:

- Measurement insert with ceramic terminal block or head transmitter
- Thermowell
- Process connection
- Neck/lagging
- Terminal head with cable glands

DIN-STYLE



The **terminal head** is fitted to the thermowell or the neck of the thermometer.

Benefits:

- Protection and installation for terminal block or transmitter
- Cable entry and wiring
- Display (as option)

US-STYLE



The **neck** or **lagging** is the connection between terminal head and process connection/thermowell.

Benefits:

- Protection of the head transmitter from overheating
- Guarantees access to the terminal head in the case of pipe insulation

The **process connection** is the connection between the process and the thermometer.

Normally used are:

- Threads
- Flanges
- Weld-in connections
- Compression fittings

The **thermowell** is the process wetted component of the thermometer.

Benefits:

- Increases the life cycle of the measurement insert through protection against process influence.
- Possible measurement insert exchange under process conditions.
- Mechanical stability against pressure and flow



Measurement inserts

Basics and measurement principles – Temperature is the most frequently measured parameter in the process industry. In electrical, contact thermometers two measurement principles have asserted themselves as a standard.

RTD - Resistance sensors

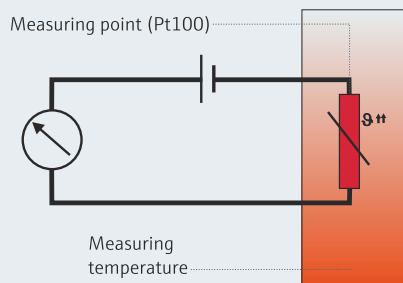

In RTD resistance sensors the electrical resistance changes with a change in temperature. They are suitable for the measurement of temperatures between $-200\text{ }^{\circ}\text{C}$ and approx. $600\text{ }^{\circ}\text{C}$ and stand out due to high measurement accuracy and long-term stability. The resistance sensor element most frequently used is a Pt100.

It is about a temperature-sensitive measuring resistance made of platinum with a resistance value of $100\ \Omega$ at $0\text{ }^{\circ}\text{C}$. The temperature coefficient is fixed with $\alpha = 0.003851\text{ }^{\circ}\text{C}^{-1}$.

Pt100 sensors are manufactured in different formats:

- **Wire wound ceramic sensors:** In a ceramic tube there is a double coil with capillary ultra-pure platinum wire. This tube is sealed at the top and bottom by a ceramic protective coating. These sensors ensure good long-term stability of their resistance/temperature characteristic in the temperature range of up to $600\text{ }^{\circ}\text{C}$.
- **Thin-layer sensors:** In a vacuum a very thin platinum coating of about $1\ \mu\text{m}$ is sputtered onto a ceramic plate and is then photo-lithographically structured. The emerging platinum conductors form the sensor resistance. The advantages over the wire-wound versions are the smaller dimensions and the better vibration resistance. Thin-layer sensors are used for temperature measurements in temperature ranges of up to $500\text{ }^{\circ}\text{C}$.

As a standard, Endress+Hauser RTD resistance sensors fulfill the IEC 60751 accuracy class A.

TC - Thermocouples

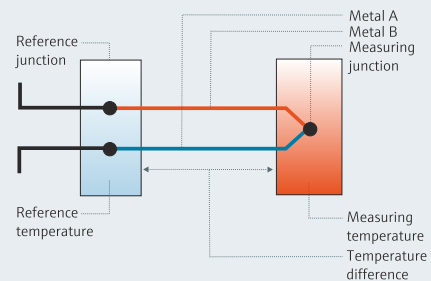

A thermocouple is a component made of two different metals connected with each other at one end. An electrical potential (thermoelectric force) is caused due to the Seebeck effect at the open end if the connection and the free ends are exposed to different temperatures. With the help of the so-called thermocouples reference tables (see IEC 60584) the temperature at the connection (measuring junction) can be concluded.

Thermocouples are suitable for temperature measurement in the range of $0\text{ }^{\circ}\text{C}$ to $+1800\text{ }^{\circ}\text{C}$. They stand out due to the fast response time and high vibration resistance.

Design

Measurement inserts consist of a SS316L stainless steel, Alloy 600 or Pyrosil tube inside. The internal leads (RTD) or thermal leads (TC) are placed and insulated from each other by magnesium oxide (MgO) powder.

The sensor is located at the tip of the measurement insert. The electrical contact at the top end of the measurement insert is made, in the simplest case, by the use of flying leads, a terminal block or a head transmitter. Measurement inserts are available with a single sensor or, for redundant measurement, with two sensors.

In order to guarantee thermal contact to the process the measurement inserts are pushed onto the base of the thermowell by means of two springs on the fixing screws or one spring on the collar (U.S. style: 'spring loaded').

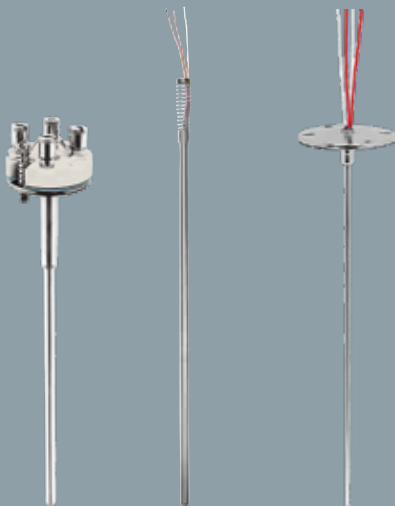



Measurement insert:
Flying leads, US-Style 'spring loaded',
ceramic block and head transmitter



Thermowells

Fabricated thermowells

Model	TA414	TW251	TT131
Design			
Thermo- meter connection	Adapter for TST414	Compression fitting: Ø9 mm M24 x 1.5, ½" NPT	Male thread: M24x1.5, NPT ½", G ½" female thread: M20x1.5, ½" NPT, G ½" QuickNeck
Process connection	G ½"	G ½", G ¾", ½", weld-in adapter, 25 x 30 mm, cylindrical or spherical	male threads: metrical, NPT, G, R; flanges as per EN and ANSI standard; compression fittings, weld-in adapter
Neck/extension	without	without	available
Material	1.4571	1.4435	Stainless steel: 316, 316L, 316Ti, 321, Alloy446 nickel-based materials: AlloyC276, Alloy600, jackets in Tantalum and PTFE
Suitable for	TST414 only	Thermowell for TST410, TEC410, TST310 or TSC310	TM131, TR10, TR11, TR12, TR13, TR88, TC10, TC11, TC12, TC13, TC88, TST310, TSC310

The thermowell is the process wetted part of the thermometer. Basically, thermowells are divided into protection tubes constructed from welded tubes and thermowells made of drilled barstock material.

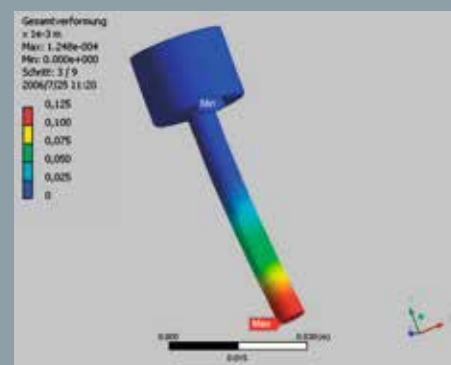

Computer simulation showing the loading of a thermowell in process

Thermowell construction

In many cases thermometers cannot be placed directly into the medium but need protection from rough process conditions. Furthermore the thermowell makes sure that an exchange of the measurement insert is possible without interrupting the process.

Correct construction and design of a thermowell requires exact calculations. The load capacity of thermowells in individual processes is calculated at Endress+Hauser according to the Dittrich /Kohler method which represents the basis of the DIN 43772.

The calculation can alternatively be carried out according to ASME / ANSI PTC 19.3, i.e. the Murdock method.



Interested? Have a look: www.endress.com/appliator



- Select and size product
- Sizing & documentation
- Sizing thermowell



Thermowell calculation tool



The "Sizing Thermowell Tool" can be found on the Endress+Hauser website for online calculation and engineering of all Endress+Hauser thermometer thermowells.

Barstock thermowells



Model	TW15	TT151	TT511
Design			
Thermometer connection	Male Thread: M24 x 1,5 (Neck) Female Thread: M14, M18, 1/2" G, 1/2" NPT	M14, M18, M20, M27, 1/2" NPT, 1/2" G, 3/4" G, 1/2" NPSC, 1/2" NPSM	
Process connection	Flange according to EN 1092/ANSI, or weld-in	Variety of threads Variety of flanges according to EN 1092, ANSI, JIS or ISO7005-1 standard	Collar flange according to EN 1092 or ANSI
Neck/extension	40 to 400 mm	Lagging: according to customer needs	25 mm (type 1)
Material	10 CrMo9-10 / 316Ti / 13CrMo4-5 C22.8, S32205, Titan Gr.2 16Mo3 / Alloy C276	316, 316L, 316Ti, 347, 310 Alloys 600, C276, 10CrMo9-10, 13CrMo4-5, 16Mo3 A105, C22.8 Duplex S32205, Titan Gr.2	1.4401, 1.4571
Suitable for	TR15 / TC15	TM131, TR88/TC88, TR15/TC15	TM131



Thermowells for hygienic applications

Model	TT411	TT412	TT411/412
Design			
Thermometer connection	M24x1.5, G3/8", iTHERM QuickNeck	½" NPT, iTHERM QuickNeck	G3/8", ½" NPT
Process connection	Clamp as per ISO 2852, DIN 11851, Varivent, weld-in adapter, thread, Ingold, SMS 1147, APV inline, DIN11864, metallic sealing system, Neumo-Biocontrol	Clamp as per ASME BPE or ISO 2852, Varivent, weld-in adapter, thread	DIN 11865 series A, B, C
Neck/extension	As per DIN 43772, 65 mm	Variable or predefined	Predefined
Material	316L 1.4435+316L, delta ferrite <1% 1.4435+316L, delta ferrite <0.5%	316L	1.4404, 1.4435, 1.4435+316L, delta ferrite < 0.5%
Suitable for	TM411, TM371, TM311	TM412, TM372, TM311	TM411, TM412, TM371, TM372, TMR311

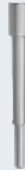
US Barstock thermowells

Model	TU51	TU52	TU53	TU54
Design				
Thermometer connections	½" NPT	½" NPT	½" NPT	½" NPT
Process connection	Weld-in Ø ¾", Ø1"	Socket weld process connections	Thread ½" NPT, ¾" NPT, 1" NPT	Flange according to ASME
Neck/ extension	1"-6" cylindrical	1"-6" cylindrical	1"-6" hexagonal	1"-6" cylindrical
Material	SS316	SS316	SS316	SS316
Suitable for	T15, T55	T15, T55	T15, T55	T15, T55

Sensor technology for thermometers

Innovative sensors for every measurement application

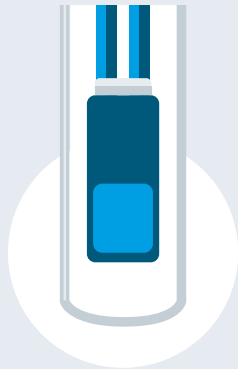

**Basic thinfilm
Pt100 (RTD)**

- Thinfilm sensor consisting of ceramic substrate with vapor-deposited platinum
- Sensing element and wiring in stainless steel sheath



**Standard thinfilm
Pt100 (RTD)**

- Small sensor consisting of ceramic substrate with vapor-deposited platinum
- Embedded in mineral isolated stainless steel sheath

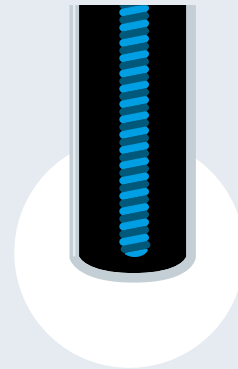

**Wirewound
Pt100 (RTD)**

- Ultrapure platinum wire wound around a ceramic core
- Embedded in mineral isolated stainless steel sheath

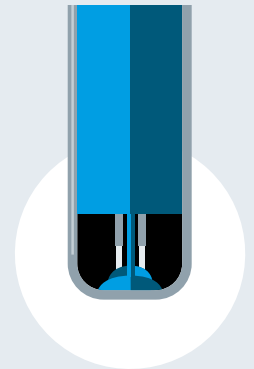

**iTHERM QuickSens
Pt100 (RTD)**

- Pt100 thinfilm sensor with the world's fastest response time
- Sensor-on-tip technology for short immersion length
- Better process control and product quality, optimized efficiency
- Highest accuracy

Measurement range

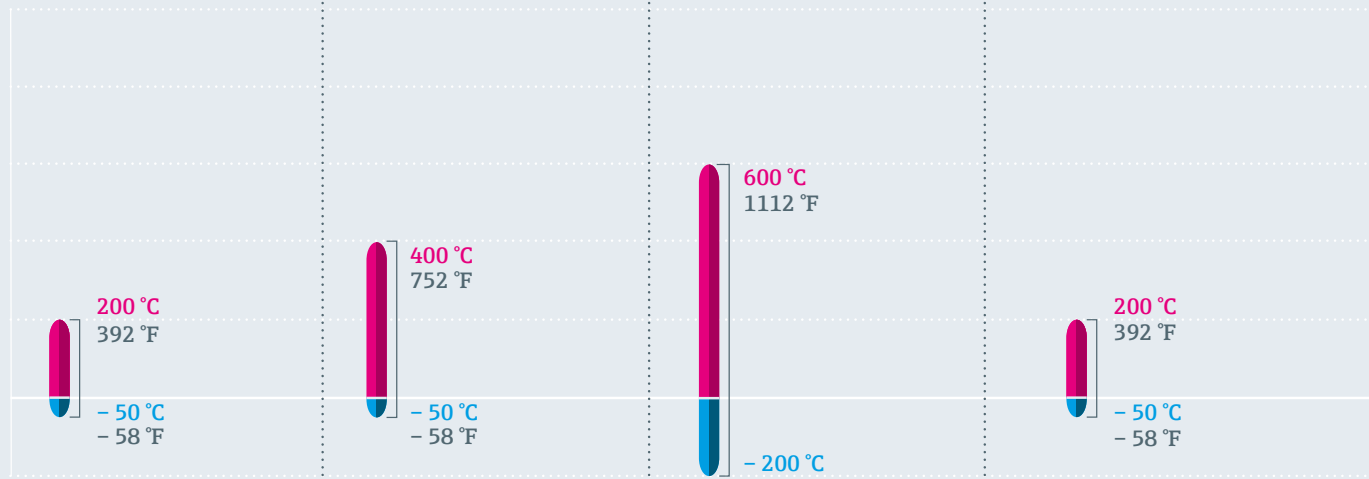

Properties

- | | | | |
|---|--|--|--|
| <ul style="list-style-type: none"> + Measurement performance sufficient for most support processes + Excellent price/performance ratio - Limited measurement range | <ul style="list-style-type: none"> + Long-term stability + Vibration resistance - Limited measurement range | <ul style="list-style-type: none"> + Long-term stability + High measurement repeatability - Relative cost - Susceptible to mechanical stress | <ul style="list-style-type: none"> + World's fastest response time + Maximum process safety - Limited measurement range |
|---|--|--|--|

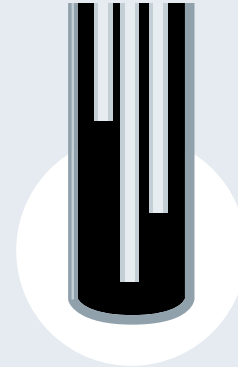
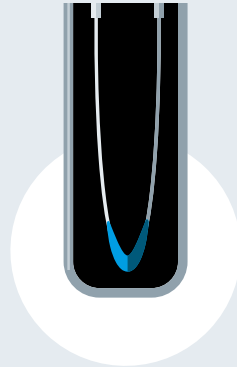
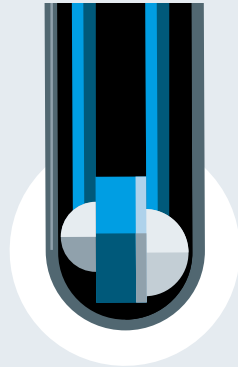
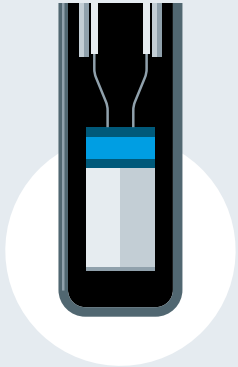

**iTHERM StrongSens
Pt100 (RTD)**

- Ceramic-encapsulated Pt100 thinfilm RTD with unmatched robustness
- Vibration resistance up to 60g for lower life cycle cost
- High long-term stability, high plant availability

**iTHERM TrustSens
Pt100 (RTD)**

- Self-calibrating sensor unit
- Pt100 sensor and integrated fixed point reference
- Higher product quality and safety
- Lower risk, cost and effort

Thermocouple (TC)

- Two dissimilar metals spot welded (hot junction)
- Ideal for high temperatures

**iTHERM ProfileSens
Thermocouple (TC)**

- Minimally invasive multipoint cable sensor profiling system
- Up to four individual thermocouple sensors per probe
- MI cable mineral insulated (MgO powder)
- Robust design with double metal sheathing technology

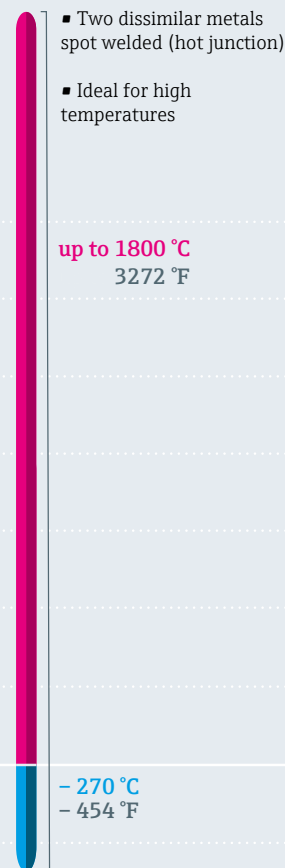
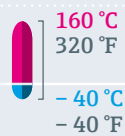

- + World's highest vibration resistance
- + Robust
- + Long lifetime and plant availability
- Response time

- + Self-calibrating
- + High accuracy
- + Reliability
- + High degree of automation
- + Risk reduction
- Limited measurement range

- + Measurement range
- + Ideal for high temperatures
- Long-term stability
- Limited accuracy

- + Robust and reliable
- + For high temperatures, pressure, aggressive media
- + Increased plant safety
- Limited accuracy

Process connections

The process connection is the connection between the process and the thermometer.
The following process connections are those most commonly used in the process industries:

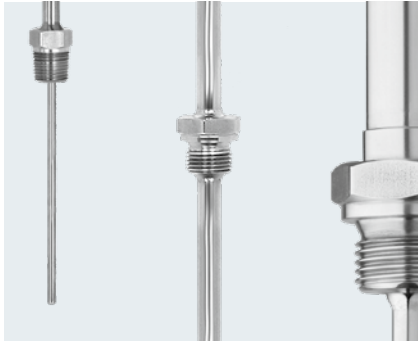

Thread: The most commonly used thread types are NPT-, G- and M-threads:

- The ANSI B 1.20.1 NPT thread is a U.S. thread norm for self-sealing pipe threads. Sealing is achieved through conical threads.
- G threads are cylindrical pipe threads and seal using the sealing area above the thread.
- M threads are metric threads which are used at low process pressures. M threads are frequently used on thermometers that are to be screwed into already existing thermowells on site.



Welded joint: The thermowell is directly welded into the container or pipe wall via a welding sleeve or a welding adapter.

Compression fitting: The thermometer is put into a sleeve in the compression fitting and then clamped using either a reusable compression ring or a non-detachable olive.

The compression fitting is either screwed or welded into the process.



Flange: Flanges are subject to the DIN or ANSI / ASME standards. They are classified according to material, diameter and pressure rating.

To fulfill the strongly varying process conditions a variety of sealing geometries are available.

Process connections for hygienic and aseptic application

Seals in hygienic process connections must be replaced at fixed intervals. Fast and simple exchange of the complete thermometer as well as simple cleaning in the process have led to special hygienic process connections for the Food & Life Sciences industry.

Connection	Clamp according to ISO 2852	DIN 11851	DIN 11864	SMS	Weld-in adapter	Screw-in adapter	Varivent	Ingold	Metallic sealing connection
Design									
Size	DN8/18 DN12/21,3 DN25/38 DN40/51 Tri-Clamp 1/2", 3/4", 1 1/2", 2"	DN 25 DN 32 DN 40 DN 50	DN 25 DN 40	DN 25	Cylindrical or spheric cylinder 30 x 40 mm	G 1", as for Liquiphant M	DN32/125, D = 68 mm DN25, D = 50 mm DN10/15, D = 31 mm	25 x 30 mm, 25 x 50 mm	M12x1.5, G 1/2"
Available for	Metrical design: TM401, TM411, TMR35, TTR35 Imperial design: TM402, TM412								

Terminal heads

The terminal heads, in which the terminal block or transmitter is installed, differ in shape and material depending on the application. Materials used are: Plastic, varnished aluminum or stainless steel. All terminal heads have an internal form according to DIN 43729 (form B). Various threads for thermometer connection (M24, NPT $\frac{1}{2}$ ") or cable connection (M20, NPT $\frac{1}{2}$ " , NPT $\frac{3}{4}$ " , G $\frac{1}{2}$ ") are available. Moreover, a large selection of cable glands and connectors is available.

TA30A	IP	TA30A double cable entry	IP	TA30H	IP	TA20B	IP
	66/ 67		66/ 67		66/ 67		65
Form B standard (optional with display)		(optional with display)					
TA30D	IP	TA30EB	IP	TA30H double cable entry	IP	TA30R	IP
	66		66/ 67		66/ 67		69K 66/ 68
Form BUZH						(without display) (with display)	
TA30P	IP	TA30S	IP	TA30H SS	IP	TA20AB	IP
	65		66		66/ 68		66/ 68

Terminal heads offering maximum comfort

- With high or low cover.
- With screw-on cover even in explosion-proof version (XP).
- Cover with display window for process value and diagnostic messaging display.
- Internal and external grounding screws.
- Simple connection cable feed by means of a spiral cable guide well.
- Easy access to mounting platform for head transmitter or terminal block installation.
- Simple identification due to explicit nameplate positioning.
- Double cable entry
- Optional with wall or pipe mounting
- Connectors

iTHERM TA30R - Stainless steel terminal head for hygienic applications

✓ Benefits at a glance:

- Improved handling, reduced installation and maintenance costs by optimal access to the terminals
- Optional display - safety due to on-site process display
- High cover version for installation of two transmitters, optional
- Protection class IP69K - optimal protection even when using high-pressure cleaners



Transmitter



The task of transmitters is the transformation of the sensor signal into a stable and standardized signal. In the past, transmitters were built using analog technology. In the meantime digital technology has gained acceptance, however, because it offers better measurement accuracy at simultaneously higher flexibility.



Transmitters are typically offered in three distinctive types of housing:

- As DIN rail mounted devices suitable for panel installation.
- As head transmitters for direct installation in thermometer terminal heads.
- As field transmitters for direct connection in the process areas.

Transmitters are configurable and support both numerous resistance sensor types and thermocouples. In order to obtain the highest measurement precision, linearization characteristics for every type of sensor are stored in the transmitter.

In addition, the measurement accuracy in modern transmitters can be improved by use of a specific 'sensor-transmitter-matching' software. The complete measuring chain consisting of transmitter and sensor is then matched with each other. On the one hand, the standardized output signal in the process measurement is a 4...20 mA signal, but also the internationally standardized field buses, such as HART®, PROFIBUS® and FOUNDATION™ Fieldbus are used. The HART® protocol serves mainly for a more convenient operation in combination with the 4 to 20 mA analog measured signal. PROFIBUS® and FOUNDATION™ Fieldbus, however, transfer the real measured value digitally and offer the possibility to transfer the device status simultaneously.

The plug-on display TID10 can be used in connection with a TMT82, TMT84, TMT85 or TMT7x head transmitter. Simply plug it onto the head transmitter and the display will be switched on. It displays information regarding the actual measured value, the measurement point identification and events of fault in the measurement chain. DIP-switches can be found on the rear of the display. This enables the hardware set-up such as the PROFIBUS® device address. With the optional field housing TA30x the device is suitable for use in the field, even a use for Ex d applications is possible without problems.



Endress+Hauser is one of the pioneers in fieldbus technology and plays a worldwide leading role in the application of the HART®, PROFIBUS® DP/PA and FOUNDATION™ fieldbus technology.

- Accredited PROFIBUS® competence center
- Engineering of field bus networks
- System integration checks
- Training courses, seminars
- Customer service
- Endress+Hauser's own fieldbus laboratory

Device configuration

HART®

HART® signal for on-site or centralized device set-up using a hand-held terminal or PC. Operation, visualization and maintenance at the PC using FieldCare, AMS, PDM or ReadWin 2000 software.

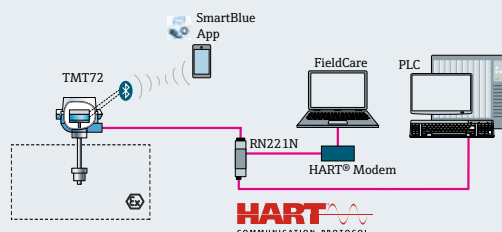

Fieldbus

Temperature transmitter for PROFIBUS® PA and FOUNDATION™ Fieldbus enables data exchange and operation using standardized fieldbus protocols.

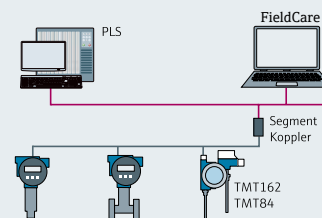





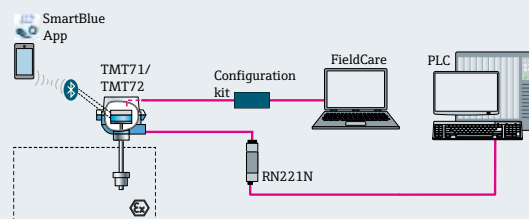







PC programmable



Online configuration with SETUP connector and operating software.



iTEMP Temperature transmitters at a glance

Head/DIN rail transmitters					
Type					
Model	TMT71	TMT72	TMT82	TMT84	TMT85
Design					
Top-hat rail					
Special feature	PC interface, Bluetooth® interface, universal	HART® interface, Bluetooth® interface, universal	HART®, 2-channel, backup, drift, SIL2/3, universal	PROFIBUS® PA, 2-channel, backup, drift, universal	FOUNDATION™ Fieldbus, 2-channel, backup, drift, universal
RTD input	IEC: Pt100/Pt200/Pt500/Pt1000 GOST: Pt50/Pt100/Cu50/Cu100/Ni100/Ni120 JIS: Pt100 Callendar-Van Dusen		Pt100/200/500/1000 Ni100/120/1000 Cu10/50/100 (Cu50 for TMT82) GOST: Pt50/100, Cu50/100 (Cu50 for TMT82) Polynomial RTD, Callendar-Van Dusen		
TC input	B, C, D, R, S, E, J, K, L, N, T, U (also type A for TMT82, TMT71, TMT72)				
Input Ω	10 to 2000 Ω				
Input mV	-20 to 100 mV				
Accuracy (Pt100)	0.1 K @ measuring range (0 to 200 °C)	Digital: 0.1 K Analog: 0.03% of measuring range		Digital: 0.1 K Analog: 0.03% of measuring range	
Certificates/ approvals	ATEX: Ex ia/na; cCSAus IS, N; EAC; NEPSI; INMETRO; IECEX Radio approvals for Bluetooth®		ATEX: Ex ia, FM/CSA: IS, dust ignition-proof zone 22; NEPSI, IEC Ex		

Field transmitters







Type		
Model	TMT162	TMT142
Design		
DIN rail		
Special features	Illuminated display, 2-chamber device, 2-channel, back-up, drift, SIL2/3, NE89 for HART®, with overvoltage protection as option for the HART® version	Illuminated display, optionally available with Bluetooth® interface and integrated overvoltage protection
RTD input	Pt100/200/500/1000 Ni100/120/1000 Cu10/50/100 GOST: Pt50/100, Cu50/100 Polynom RTD, Callendar/Van Dusen	
TC input	B, C, D, R, S, E, J, K, L, N, T, U	
Ω input	0 to 2000 Ω	
mV input	-20 to 100 mV	
Accuracy (Pt100)	digital: 0.1 K analog: 0.02% of the set span	digital: 0.15 K analog: 0.03% of the set span
Approvals	ATEX: Ex ia, Ex d, FM/CSA: IS, XP, DIP, Dust-Ex Zone 21, GL ship building approval, GOST (for HART®), NEPSI, IEC Ex	ATEX / IECEx: Ex ia, Ex d cCSAus: IS, XP, EAC, NEPSI, INMETRO

E-direct transmitters

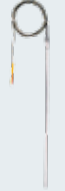
Model	TMT180	TMT80	TMT187/127	TMT188/128
Design + DIN rail				
Input	RTD: Pt100	RTD: Pt100, 1000 TC: B, K, N, R, S	RTD: Pt100	TC: B, C, D, E, J, K, L, N, R, S, T, U, MoRe5-MoRe41
Accuracy	≤ 0.2 K or 0.08%	RTD: 0.2 K or 0.08% TC Typ K, N: typ. 1.0 K or 0.15% TC Typ S, B, R: typ. 2.0 K or 0.15%	0.2 K or 0.08%	0.2 K or 0.08%

Compact thermometers

Cable probes and compact thermometers overview

Type	Cable sensor, metric and imperial					Compact thermometer, metric and imperial			
Model	TST310	TSC310	TH12	TH52	TH56	TTR31/TTR35 (E-direct)	TMR31/ TM311/ TMR35 (E-direct)	TM371/TM372	
Design							 IO-Link		
Special feature	Compact thermometers with permanently affixed plug-in or screw-in cable		Compact RTD resistance thermometers with permanently affixed plug-in or screw-in cable	Compact TC thermometers with permanently affixed plug-in or screw-in cable (TH52) or connector (TH56)		Temperature switch with 1/2 PNP switch outputs, 4 to 20 mA	Compact thermometers with integrated transmitter. Short insertion length, extremely fast response times	Compact thermometers for hygienic and aseptic applications, exceptional sensor technology with self-calibration function, HART® protocol	
Approval	ATEX Ex ia, ATEX Ex nA, IECEx Ga Ex ia, NEPSI Ex ia			-		UL 61010B-1 and CSA C22.2 no. 1010.1-92	UL as per 3111-1, marine approval	EHEDG, ASME BPE, FDA, 3-A, EC 1935/2004, EC 2023/2006, EU 10/2011 - CE/EAC, CRN, CSA universal version	
Measuring principle	RTD	TC	RTD	TC			RTD		
Measuring range	-50 to +400 °C	Type J: -40 to +750 °C Type K: -40 to +1100 °C	-50 to +200 °C (-58 to +392 °F)	Type J: -346 to +1330 °F (-210 to +720 °C) Type K: -454 to +2100 °F (-270 to +1150 °C)		-50 to +150 °C (-58 to +302 °F)	-50 to +200 °C (-58 to +392 °F)	-40 to +160 °C (-40 to +320 °F)	
Process pressure	≤ 100 bar (depending on process connection)							≤ 50 bar (depending on process connection)	
Material	1.4404	1.4404, 2.4816	SS316L			1.4404		316L, 1.4435+316L, delta ferrite <1%	

Simple, fast and economical Cost efficiency and optimal use of space indicate modern process measuring technology. Particularly OEM applications require fast delivery times, reliable operation as well as simple assembly and calibration of the measurement technology used.

The compact families completely fulfill these requirements. They are easily commissioned, measure reliably, and when required convert into standard signals and alert at alarm limit violation.

- Precise primary sensors, long-term stable electronics.
- Robust construction in stainless steel, compatible connection technology.
- Versatile process adapters, flexible sensor lengths.
- Simplest assembly as well as on-site and PC parameter set-up.
- Patented sensor concept

Output signals The primary sensor signal is accessed via a choice of high-quality connecting cables in 3- or 4-wire circuit, IO-Link or 4 to 20 mA signal measurement at the standard connector.

Meter electronics The TM311/TMR31/TMR35 measurement electronics board measures only 40 x 18 mm and can be programmed as required. The Thermophant TTR31 can also be operated via a keypad and switches in the event of a limit value violation.

Process connections Compression fittings, imperial and metric stainless steel threads guarantee compatibility worldwide. Hygienic process adapters and thermowells satisfy EHEDG, 3-A, FDA, ASME and BPE requirements.

Sensors Vibration-resistant, integrated, thin-film Pt100 sensors guarantee a high level of operational safety while ensuring the fastest response.

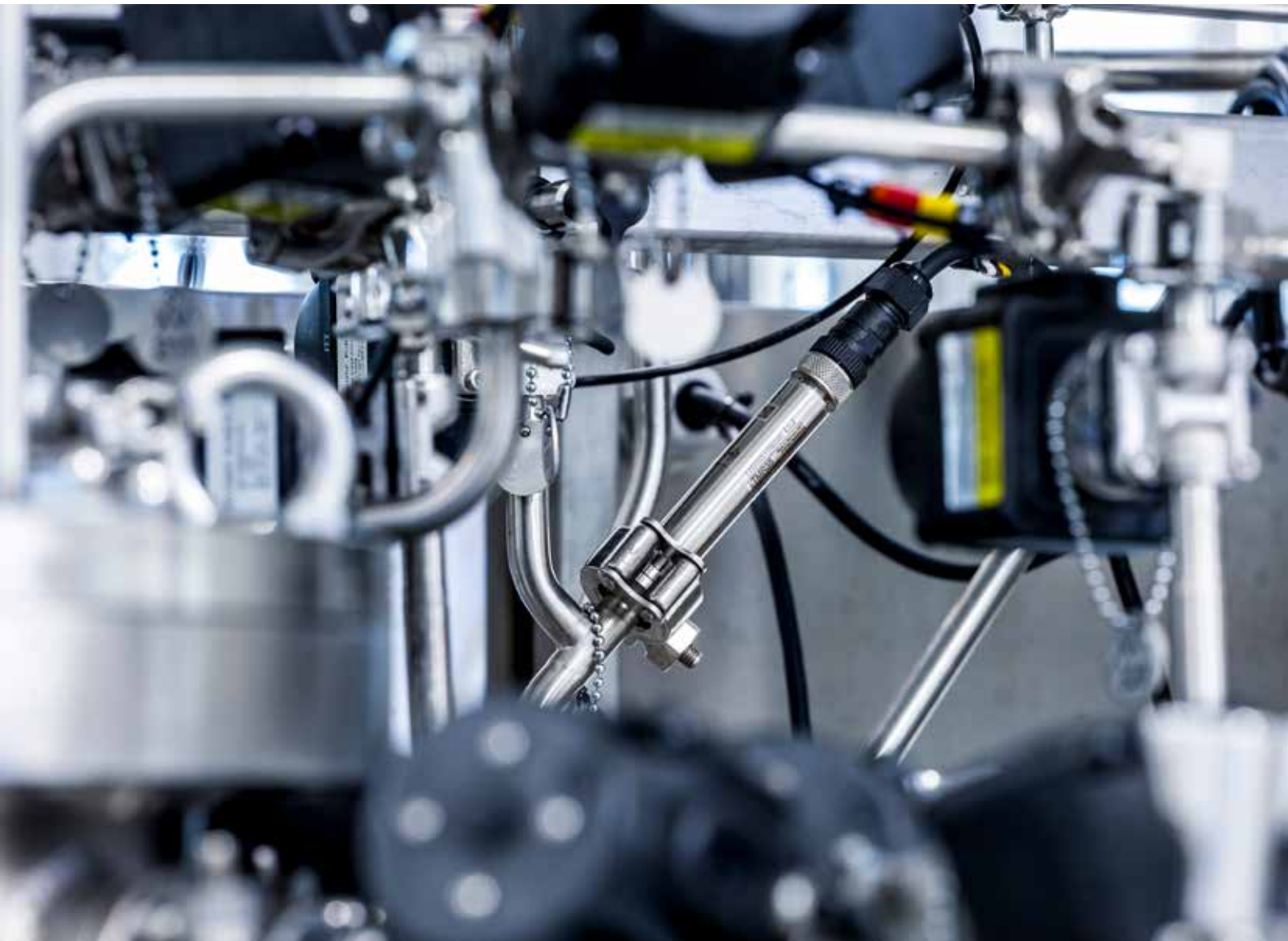

Thermophant TTR31
temperature switch

 IO-Link



iTHERM CompactLine
TM311 compact
thermometer – universal
output in 4 to 20 mA and
IO-Link



Easytemp TMR31 compact
thermometer – with meter
electronics and long
immersion length



Without meter electronics,
with short immersion length

iTHERM TrustSens

World's first self-calibrating thermometer

100% compliance – 0% complexity

The new iTHERM TrustSens TM371 and TM372 enable continuous, traceable monitoring thanks to the fully automated inline self-calibration function without process interruption. This results in high product safety, increases plant availability and helps reduce risk and costs. The hygienic thermometer is designed for users in the pharmaceutical and food & beverage industries who require absolute compliance with FDA and/or GMP regulations.

At the heart of the temperature probe is a unique sensor unit consisting of a primary Pt100 temperature sensor and a highly accurate, integrated reference with long-term stability. The reference sensor uses a physical fixed point on the basis of the Curie temperature and therefore serves to regularly calibrate the primary sensor. The self-calibration is triggered fully automatically at a temperature of 118 °C (Curie point of the integrated reference), a process typically occurring during each steam sterilization (SIP) of the plant. This ensures that the constantly high measuring accuracy of the temperature sensor is permanently monitored throughout its entire life cycle.

"Heartbeat Technology" in temperature measurement

The integrated smart electronics feature varied diagnostics functions, which are categorized in line with the NE 107 NAMUR recommendation and transmitted via HART® communication. Furthermore, status signals are indicated locally by means of the LED integrated in the device. In addition to the automated calibration, and therefore verification of the thermometer's measuring accuracy, data from the last 350 calibrations is stored directly in the device (FIFO memory). This makes it possible to access a long device and process history, which can be used as the basis for predictions and the early determination of trends. These features guarantee continuous, fully autonomous device self-diagnostics. The iTHERM TrustSens is therefore ready for Industry 4.0 applications.

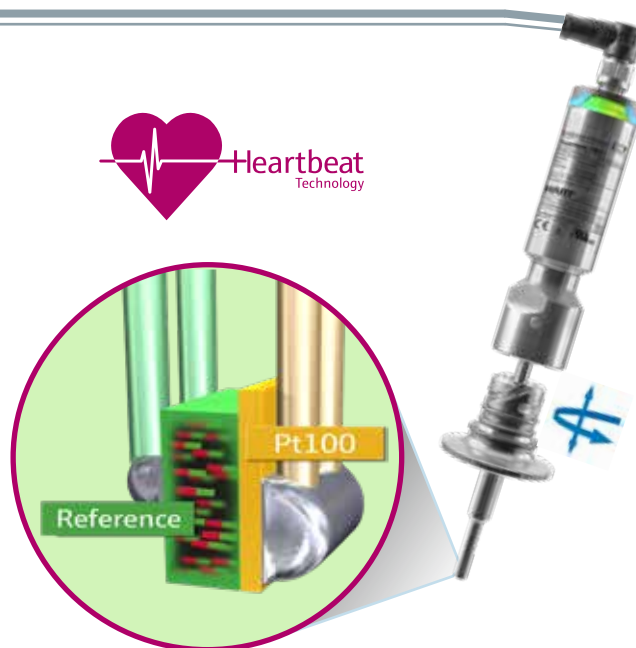

i iTHERM QuickNeck

Removable neck tube with quick fastener:

- Tool-free removal of the thermometer
- IP69K protection

Self-calibration with TrustSens

- **Self-check:** TrustSens features a built-in reference sensor that cyclically monitors the primary Pt100 temperature sensor during the active process.
- **Operation:** The process is not interrupted. Maintenance personnel is only required when the sensor reports a malfunction.
- **Reference measurement:** The reference sensor uses the fixed Curie temperature point at 118 °C (239 °F) to trigger a self-calibration. This typically occurs for example during a steam cleaning cycle.



For more information please visit www.endress.com/trustsens

✓ Documentation

- Built-in memory for 350 calibration points
- FieldCare by Endress+Hauser makes issuing calibration certificates possible at any time
- The automatically generated documentation is 100% audit-proof

Integrated product and service offering

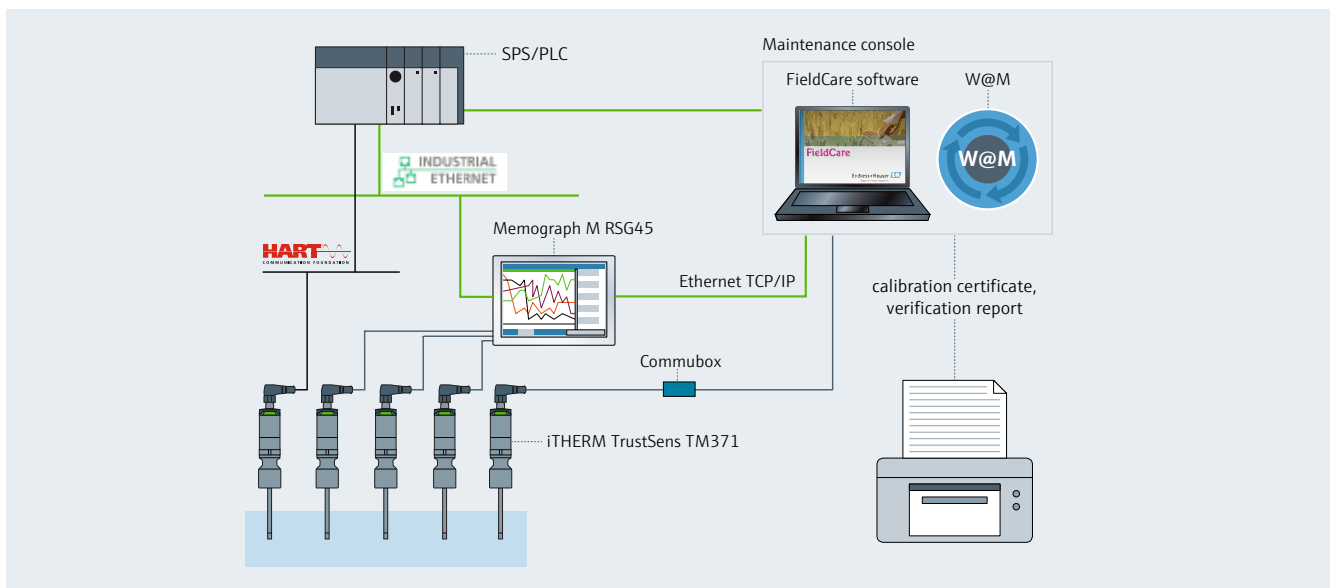

Data Management Memograph M RSG45	<ul style="list-style-type: none"> ▪ Tamper-proof data storage and access (FDA 21 CFR 11) in combination with FDM Software MS20, Field Data Manager Software by Endress+Hauser ▪ HART® gateway functionality; Up to 40 HART® devices connected at a time ▪ Communication capabilities: Modbus, PROFIBUS DP, PROFINET, EtherNet/IP
Display unit RIA15	<ul style="list-style-type: none"> ▪ Display of 4 to 20 mA measured values or HART® process variables ▪ The RIA15 can be used to display TrustSens values such as: temperature, electronic temperature, calibration counter, calibration offset ▪ Loop-powered; Voltage drop ≤ 1 V (HART® ≤ 1.9 V)
Field Data Manager Software MS20	<ul style="list-style-type: none"> ▪ Automatic service for report generation, printing reports, read out of data, storing of data, secure export, pdf generation ▪ Create reports and templates ▪ Read out measured data via online interface or from mass storage ▪ Online visualization of instantaneous values ("live data")
Commubox TXU10 Commubox FXA195	<p>Quick and easy link between TrustSens and PC via USB interface for fast device configuration</p> <p>Intrinsically safe HART® communication with FieldCare via USB interface</p>
Endress+Hauser Service	<ul style="list-style-type: none"> ▪ Commissioning service ensures optimal startup and reliable base for future self-checks ▪ Technical experts are always on call to support with product queries

✓ Advantages at a glance

- Maximized process safety through self-calibration and Heartbeat Technology
- No production downtime due to fully automated and traceable inline self-calibration
- Fully automated documentation - audit-proof
- Highest measuring accuracy through characteristic adjustment (Sensor-Transmitter Matching)
- International certifications and approvals: EHEDG, ASME BPE, FDA, 3-A, 1935/2004, 2023/2006, 10/2011, CE, CRN, CSA General Purpose
- Measuring range: -40 to $+160$ °C (-40 to $+320$ °F)
- More than 50 sterile and hygienic process connections as standard





Industry applications:

- Life Sciences
- Food & Beverage

ModuLine – Thermometers with metric design









Endress+Hauser offers a broad portfolio of temperature measurement technology for comprehensive solutions for almost all branches of industry. The measurement principles used are RTD resistance sensors and thermocouples. Important points for the inclusion of the measurement point into the process are the protection of the thermometers through thermowells and the process connection.

These thermometers are used mainly in the chemical industry but also in core and peripheral processes across all industries. The innovative iTHERM ModuLine thermometers were developed for a very wide range of applications in a variety of industries and meet the highest quality standards.

Type	Metric design			
Model	TM101	TM111	TM121	TM131
Design				
Insert	Stainless steel insert for RTD, mineral-insulated sheathed cable for TC	Mineral-insulated sheathed cable, cannot be replaced Ø3 mm and 6 mm	Stainless steel insert for RTD, mineral-insulated sheathed cable for TC	Mineral-insulated sheathed cable, cannot be replaced Ø3 mm and 6 mm
Measuring range	RTD: -50 to 200 °C (-58 to 392 °F) TC: up to 1100 °C (up to 2012 °F)	RTD: -200 to 600 °C (-328 to 1112 °F) TC: up to 1100 °C (up to 2012 °F)	RTD: -50 to 200 °C (-58 to 392 °F) TC: up to 650 °C (up to 1202 °F)	RTD: -200 to 600 °C (-328 to 1112 °F) TC: up to 1100 °C (up to 2012 °F)
Ex approvals		ATEX IEC Ex: ia, tb, d, nA CSA C/US: GP, IS, XP, DIP EAC: ia, d NEPSI: ia, d, tb, nA		ATEX IEC Ex: ia, tb, d, nA CSA C/US: GP, IS, XP, DIP EAC: ia, d NEPSI: ia, d, tb, nA
Process connection	Thread, compression fittings, coupling nuts	Thread, compression fittings, coupling nuts, weld-in adapter	Thread, compression fittings, ANSI and DIN flanges	Thread, compression fittings, ANSI and DIN, flanges Weld-in adapter
Thermowell	Without thermowell, for direct contact with the process	Without thermowell, for direct contact with the process	Thermowell made of pipe material	Thermowell made of pipe material
Thermowell material	Insert 316L, Alloy600	Insert 316L, Alloy600	Stainless steel 316L	Stainless steel 316, 316L, 316Ti, 321 Alloys: AlloyC276, Alloy600, Alloy 446, Cover sleeve: tantalum, PTFE





The portfolio includes four basic thermometers with a modular design, and features a large number of variants. Selecting a product is extremely easy:

- There are thermometers available for direct contact with the process, and others with multi-piece thermowells.
- Both product types are segmented into basic and advanced technology.
- A graphical product configurator with integrated knowledge database is available free of charge to assist with selection.
- Saves time and money and allows operators to plan with greater certainty - incorrect orders are almost completely eliminated.

Imperial design							
TH11	TH13	TH14	TH15	TH51	TH53	TH54	TH55
							
Without thermowell, with nipple	Thermowell, with nipple	Thermowell, with nipple, flange	Without thermowell, with nipple		Thermowell, with nipple	Thermowell, with nipple, flange	Without thermowell, with nipple
MgO-sheathing, exchangeable; diameter: 6 mm							
RTD: -328 to 1112 °F (-200 to +600 °C)				TC: Type J, Type K, Type E, Type N, Type T -330 to +1600 °F (-200 to +870 °C)			
-	CSA (IS, NI)			-	CSA (IS, NI)		
Thread or compression fitting, fixed or movable	Thread or for welding	Flange according to ANSI	Threaded connection to existing thermowell	Thread or compression fitting, fixed or movable	Thread or for welding	Flange according to ANSI	Threaded connection to existing thermowell
-	Drilled barstock thermowell		-	-	Drilled barstock thermowell		-
-	SS316 or Alloy 600		-	-	SS316L, Alloy 600, Alloy C276, Titan, Alloy 400		-

iTHERM ModuLine

Thermometer Selection Guide

iTHERM product	Temperature range	Measurement performance *	Ex	SIL IEC 61508	Output 4 to 20 mA
 TM101	RTD -50 to 200 °C (-58 to 392 °F)	■ direct contact	-	-	✓
	TC up to 1100 °C (up to 2012 °F)				
 TM111	RTD -196 to 600 °C (-320,8 to 1112 °F)	■■■ direct contact	✓	-	✓
	TC up to 1100 °C (up to 2012 °F)				
 TM121	RTD -50 to 200 °C (-58 to 392 °F)	■ with thermowell	-	-	✓
	TC up to 650 °C (up to 1202 °F)				
 TM131	RTD -196 to 600 °C (-320,8 to 1112 °F)	■■■ with thermowell	✓	✓	✓
	TC up to 1100 °C (up to 2012 °F)				



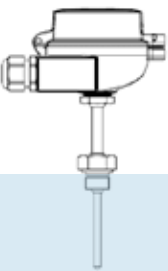
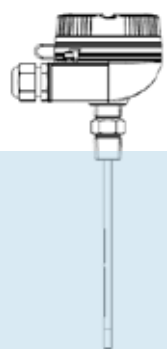
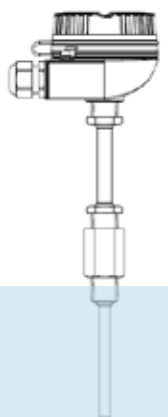

Thermometer and thermowell designs and configurations

ModuLine thermowell design versions

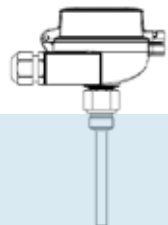
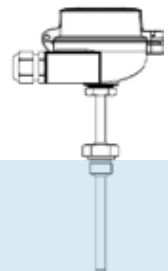
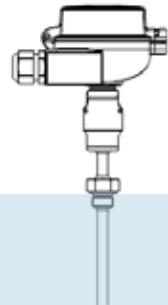
without thermowell		with thermowell
direct contact	to be installed into separate thermowell	incl. fabricated thermowell
		

ModuLine thermometer design versions

without neck (according to DIN43772 form 2)	Lagging (non-removeable neck; DIN43772 form 2G, 2F, 3G, 3F)	iTHERM QuickNeck
		

iTHERM product	Communication			Display	Highlights
	HART® 7	PROFIBUS PA	FOUNDATION™ Fieldbus		
 TM101	✓	-	-	plug-on (TID10)	price/performance
 TM111	✓	✓	✓	plug-on (TID10)	iTHERM StrongSens iTHERM QuickSens
 TM121	✓	-	-	plug-on (TID10)	price/performance including thermowell
 TM131	✓	✓	✓	integrated (back-lit) or plug-on (TID10)	iTHERM StrongSens iTHERM QuickSens iTHERM QuickNeck dual seal dual compartment housing

* Measurement performance: Valuation of accuracy input/output, long-term stability, response time

ModuLine thermometer design versions

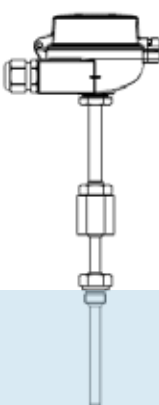
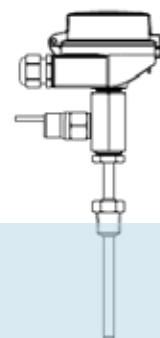
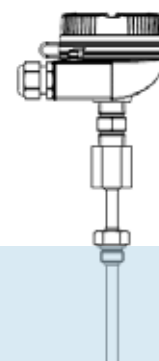
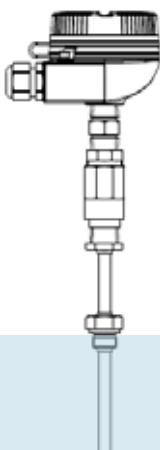
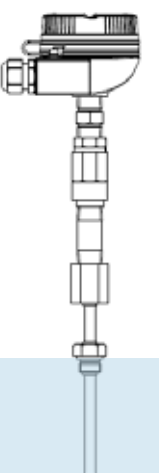
removeable neck (according to DIN43772)	second process seal	nipple-connection	nipple-union-connection	nipple-union-nipple-connection
				

iTHERM ModuLine



iTHERM QuickNeck in industrial thermometers

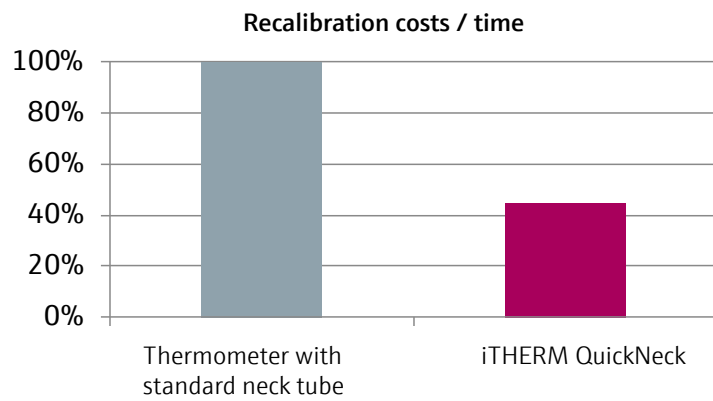

Technical Feature	Benefit	Added value
<ul style="list-style-type: none"> ▪ Removal of insert without tools ▪ Terminal head can remain closed ▪ Connection cables can remain connected 	<ul style="list-style-type: none"> ▪ Simple, easy and fast (dis-) mounting of the insert for recalibration ▪ No risk of water ingress ▪ No risk of mechanical damage ▪ No risk of wiring 	<ul style="list-style-type: none"> ▪ Cost / time savings ▪ Less downtime ▪ Higher system safety and availability

Second process barrier: Dual Seal



TM131 with second process barrier in combination with a TMT82

- Channel 1: Temperature Signal 4..20 mA
- Channel 2: Configured as TC, if pressure switch is turning a signal "sensor breakage" is generated
- Temperature signal stays alive

Technical Feature	Benefit	Added Value
<ul style="list-style-type: none"> ▪ Second process barrier for the case of thermowell failure ▪ Signal to PLC if pressure in neck is reaching 3 bar 	<ul style="list-style-type: none"> ▪ Additional health information from measurement device ▪ Temperature signal stays alive 	<ul style="list-style-type: none"> ▪ Increased process safety ▪ Reduced unplanned shutdown times ▪ Health status information

Thermowell with fast response time

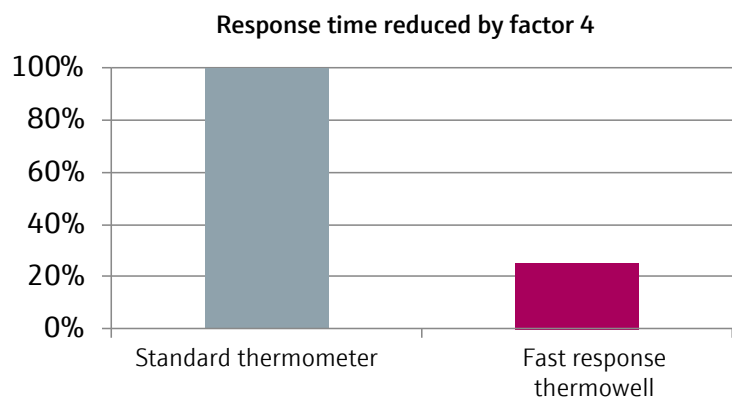

Technical Feature	Benefit	Added value
<ul style="list-style-type: none"> ▪ Heat transfer material elimination air gap ▪ Replaceable standard insert Ø6 mm ▪ Durable effective for temperatures up to 400 °C 	<ul style="list-style-type: none"> ▪ Variety of sensor types available ▪ Fastest response time in combination with thermowell 	<ul style="list-style-type: none"> ▪ Real time process information ▪ Improved process control ▪ Increased process safety and efficiency

Thermometer with barstock thermowell



Thermometers used in applications with high process pressures and flow velocities are usually fitted with barstock thermowells.

These applications place very high demands on the mechanical loading capacity and measuring technology of the thermometer.

Requirements at a glance



with display

Terminal head/communication

Field transmitter with display in 316L stainless steel for off-shore applications

Terminal head with screw cap (aluminum or stainless steel)

PC-programmable, with HART® protocol, PROFIBUS® PA or FOUNDATION™ Fieldbus

Neck/extension

Coupling piece with integrated flame path barrier, Nipple-Union-Nipple (NUN)

Process connection

Flange according to ASME/ANSI, "full penetration welding", "Greylock" connections, weld-in connections

Process wetted parts/thermowell







Process wetted parts in stainless steel: 316L / 1.4404, 316Ti / 1.4571 or Alloy C276 / 2.4819; barstock material for highest process pressures



without display



Heavy Duty Product Overview

Type	Metric design			Imperial design		
Model	TR15/TC15	TR66/TC66	TM131	T13/T53	T14/T54	T15/T55
Design						
Special features	Barstock thermowell, connection thread, with extension neck	Barstock thermowell	Thermometer for installation in separate thermowell	Stepped thermowell and spring-loaded insert	Welded thermowell with flange and spring-loaded insert	For screwing into an existing thermowell
Approvals	ATEX: Ex nA, Ex ia, Ex d IECEX: Ex tD, Ex d, Ex ia NEPSI: Ex ia, Ex nA, Ex d EAC: Ex ia, Ex d			FM/CSA XP Class 1, Div. 1		
Measurement principle	RTD Pt100 resistance thermometers and thermocouples type K and J, also type N for TM131			RTD, TC: type J, type K, type E, type N, type T		
Measurement range	RTD: -328 to 1112 °F (-200 to 600°C) TC: up to 1100°C			RTD: -58 to 392 °F (-50 to 200 °C) TC: -328 to 1600 °F (-200 to 870 °C)		
Process pressure	DEPENDING ON PROCESS CONNECTION					
	Depending on thermowell	≤ 480 bar		Depending on thermowell		
Material	WETTED PARTS					
	316Ti, 13CrMo4-5, 16Mo3, Alloy C276, titanium Gr. 2, 10CrMo9-10, C22.8, Duplex 1.4462	316, 316L, 316Ti, 310, AlloyC276, Alloy400	Thermowell must be ordered separately	1.4404/SS316L, 2.4816/Alloy 600, 2.4819/Alloy C276, titanium, Alloy 400	depending on thermowell	
Process connection	Flange as per EN or ANSI standard, for weld-in	Flange as per ANSI standard, thread	depending on thermowell	Thread, weld-in connection	Flange	Thread
Output signal	4 to 20 mA, HART®, PROFIBUS® PA, FOUNDATION™ Fieldbus			4 to 20 mA, HART®, PROFIBUS® PA, FOUNDATION™ Fieldbus		

Approvals/certificates/ tests

NACE (MR0175):

Suitability test of materials for acid gas surroundings by approval test EN 10204, 3.1 listed in the NACE standard MR0175.

Dye penetrant testing:

Dye penetrant testing according to the ASME V and ASME VIII guidelines.

X-ray test certificate:

X-ray test certificate for thermowell welding seams in accordance with ASME V – ASME VIII.

Thermowell calculation:

Thermowell calculation according to ASME PTC 19.3 using customer specific pressure, temperature and flow rate values.

Helium leakage test:

Sealing tightness test.

Pressure test:

Thermowell internal and external pressure test according to PED (Pressure Equipment Directive) in Europe or CRN (Canadian Registration Number) in North- and Central America.

Modular hygienic thermometers

The innovative iTHERM thermometers of the new, modular hygienic line have been designed to meet the requirements of the Food & Life Sciences industries and comply with highest quality standards.

For the first time a comprehensive, global product portfolio with a large selection of process connections, transmitters and further constructive variants is offered. All products - both metric and imperial - are available with the relevant international approvals.

The product choice is very simple:

- A consistent segmentation into **2 product structures** for **basic** (TM40x) and **advanced technology** (TM41x) supports the preselection of the suitable thermometer
- Support from a cost-free, graphical product configurator with integrated knowledge data base

All this saves time and costs and increases the planning security – misorders are practically impossible.

	Basic technology	Advanced technology
Device configuration	TM401 metric	TM411 metric
Insert	Not replaceable	Replaceable
Transmitter	1-channel; no display	1- or 2-channel; plug-on display (optional)
Ex-certificate	No	Yes (ATEX, IEC, FM, CSA, NEPSI)
Sensor	1x Pt100 standard thin film sensor	1x Pt100 standard thin film sensor, 1x Pt100 iTHERM QuickSens or StrongSens, 1x or 2x Pt100 wire wound
Extension neck	Standard	Standard, optional iTHERM QuickNeck

iTEMP Transmitter
Accurate and reliable measured value transmission

iTHERM QuickSens
Shortest response times worldwide:

- Fast, high-precision measurements
- Minimization of the needed insertion length
- Use of thermowells without affecting the measuring performance

iTHERM StrongSens
Unmatched robustness:

- Vibration resistance > 60g
- Automated, traceable production

iTHERM TA30R
Stainless steel terminal head:





- Optimal access to the terminals due to a low housing edge
- Optional display
- Protection class IP69K

iTHERM QuickNeck
Divisible neck with quick release:

- Removal of the insert without tools
- Protection class IP69K

A3
CERTIFIED
eHEDG
TYPE EL - CLASS I
FDA
ASME
SETTING THE STANDARD
1884 - 2002
Bioprocessing Equipment
STANDARDS COMMITTEE

Product overview modular hygienic thermometer

Type	Metric design		Imperial design	
Model	TM401 (E-direct)	TM411	TM402	TM412
Design				
Special feature	Basic technology	Advanced technology	Basic technology	Advanced technology
Certificates, compliance	EHEDG, 3-A, ASME BPE, FDA, TSE (produced without the use of animal fats)			
Measuring principle	RTD			
Measuring range	-50 to +200 °C (-58 to +392 °F)	-200 to +600 °C (-328 to +1112 °F)	-50 to +200 °C (-58 to +392 °F)	-200 to +600 °C (-328 to +1112 °F)
Process pressure	≤ 40 bar depending on process connection			
Material and surface finish	316L, Ra < 0.76 µm or < 0.38 µm	316L or 1.4435+316L, delta ferrite < 1%, Ra < 0.76 µm or < 0.38 µm; electropolished optional	316L, Ra < 0.76 µm or < 0.38 µm	316L, Ra < 0.76 µm or < 0.38 µm; electropolished optional
Response time	t ₉₀ : 9 s	t ₉₀ : 1.5 s	t ₉₀ : 9 s	t ₉₀ : 1.5 s
Process connection	Clamp as per ISO 2852, DIN 11851, DIN 11864-1, metallic sealing system, weld-in adapter, APV inline, Varivent®, Ingold fitting, SMS 1147, compression fitting; Thread: Neumo BioControl as well as T pipe section and corner pipe section as per DIN 11865			
Output signal	Pt100 3/4-wire; 1-channel iTEMP transmitter (4 to 20 mA; HART®)	Pt100 3/4-wire; 1-channel or 2-channel iTEMP transmitter (4 to 20 mA; HART®, FF, PA)	Pt100 3/4-wire; 1-channel iTEMP transmitter (4 to 20 mA; HART®)	Pt100 3/4-wire; 1-channel or 2-channel iTEMP transmitter (4 to 20 mA; HART®, FF, PA)

E+H = °C Innovative temperature measurement





✓ Benefits at a glance

- Global portfolio (metric/imperial) with international certificates
- User friendliness and security from product choice to maintenance
- iTHERM inserts: automated production - worldwide unique. Complete traceability and constantly high product quality for reliable measurement values
- iTHERM QuickSens: shortest response times (t₉₀: 1.5 s) for optimal process control
- iTHERM StrongSens: unmatched vibration resistance (> 60g) for highest plant safety
- iTHERM QuickNeck: cost and time savings through toolfree, easy recalibration
- iTHERM TA30R: terminal head from 316L with improved handling for reduced installation and maintenance costs and highest protection class IP69K
- More than 50 hygienic process connections

Next level hygienic





Temperature measurement and system products

In this section you'll find a complete overview of the industry package and its application fit. Use this selection guide for selecting the right product according to your process requirements and challenges.

Temperature measurement technology					
Product	iTHERM TrustSens TM37x	iTHERM TM41x	iTHERM TM40x	Easytemp TMR35	iTHERM TM311
Design					
Calibration	■ ■ ■	■ ■	■	■	■
Response Time	■	■ ■ ■	■	■ ■ ■ ■	■ ■ ■ ■
Analog output 4...20 mA	✓	✓	✓	✓	✓
Communication					
HART	✓	✓	✓	-	-
PROFIBUS	-	✓	-	-	-
FOUNDATION fieldbus	-	✓	-	-	-
Ex	-	✓	-	-	-
IO-Link	-	-	-	-	✓
Special feature	Self-calibration Heartbeat Technology	iTHERM QuickNeck iTHERM QuickSens iTHERM StrongSens	Cost/performance ratio	Compact dimensions Cost/performance ratio	Compact dimensions Cost/performance ratio



System products

Product	Memograph M RSG45	Ecograph T RSG35	RMA42	RIA15	RIA14/16
Design					
Input	20 universal/HART®	12 universal	2 universal	-	-
Display	7" TFT	5,7" TFT	5-digit, 7-segment illuminated display	17 mm, 5-digit, 7-segment	26 mm, 5-digit, 7-segment
Data recording	✓	✓	-	-	-
Power supply	✓	✓	✓	Loop	Loop
Communication 4...20 mA	✓	✓	✓	✓	✓
HART	✓	-	-	✓	-
PROFINET	✓	-	-	-	-
EtherNet/IP	✓	-	-	-	-
Modbus	✓	✓	-	-	-



High temperature thermometers

In glass smelters, flue gas applications and in the brick and ceramics industries temperatures up to 1700 °C can occur. This requires special thermometers with ceramic thermowells and thermocouples made from special metals, such as platinum and rhodium.

The ceramic thermowell external and sandwich coatings act as diffusion barriers. They serve as protection of the measurement point from mechanical and chemical damages in the process, e.g. from abrasive gases.

The ceramic thermowell inner sheath is the ceramic capillary.

It has the purpose of feeding and insulating the thermo wires. A higher number of ceramic protection coatings increases the life time of the measurement point.

Influences on the life time are:

- Ceramic thermowell material and temperature limit values
- Temperature shocks in the process
- Gases and vapors
- Reducing and neutral atmospheres

Requirements at a glance



Terminal head
Form A terminal head
Form B terminal head

Process connection
Gas tight compression fitting, adjustable flange or flat face flange according to DIN 43734



Process wetted parts/thermowell
Ceramic thermowell - external and dividing coating as diffusion barrier,
Ceramic thermowell - internal coating as thermo wire feeder and insulation

Sensor/measurement insert
Thermocouples type J, K or type B, S, R for application at high temperatures, with ceramic or mineral coating



The diameter of the thermowires for thermometers in the TAF series must be defined for high temperatures. The higher the process temperature is, the larger the thermowire diameter has to be chosen.

Product overview high temperature thermometers

Model	TAF11	TAF12S	TAF12D	TAF12T	TAF16
Design					
Special features	Temperature measurement in glass or ceramic furnaces. With thermowell and internal sheath made of ceramic	Temperature measurement in glass or ceramic furnaces. With ceramic thermowell	Temperature measurement in glass or ceramic furnaces. With thermowell and internal sheath made of ceramic	Temperature measurement in glass or ceramic furnaces. With thermowell and two internal sheaths made of ceramic	Temperature measurement in metal and cement industries or incinerators. With metal or ceramic thermowell, internal ceramic sheath
Measurement principle	1x or 2x TC				
Measurement range	Type B: 0 to +1820 °C Type J: -210 to +1200 °C Type K: -270 to +1300 °C Type N: -270 to +1300 °C Type S: -50 to +1768 °C Type R: -50 to +1768 °C		Type B: 0 to +1820 °C Type S: -50 to +1768 °C Type R: -50 to +1768 °C		Type J: -210 to +1200 °C Type K: -270 to +1300 °C Type N: -270 to +1300 °C Type S: -50 to +1768 °C
Max. immersion length/ diameter (mm)	1700 14, 16, 17, 22 24, 26,6	1500 9	1500 14, 15	1500 24, 26	2200 14, 15, 17,2, 18, 21,3, 26,7
Material:					
Thermowell	Ceramic C610, sinterized silicon carbide (SiC), special silicon nitride ceramic (SiN)	Ceramic C610, C799		Ceramic C530, C610, C799	AISI: 316L, 310, 304, 446, Alloy 600, Alloy 601; Alloy 800HT, Alloy C276, Kanthal AF and Kanthal Super, special nickel/cobalt alloy (NiCo), special silicon nitride ceramic (SiN)
Intermediate sheath	without	without	without	Ceramic C610, C799	without
Internal sheath	Ceramic C610	without	Ceramic C610, C799		
Process connection	Adjustable flange, gas tight compression fitting or stop flange according to DIN 50446				

Materials

Among a various number of industry standard materials, e. g. ceramics as C530, C610 and C799 or metals like AISI 316L, 310, 304, 446, Alloy 600, Alloy 601, Alloy 800HT or Alloy C276, Kanthal AF and Kanthal Super Endress+Hauser offers exclusive special materials for high temperature measurement.

For further information concerning special materials please contact your Endress+Hauser sales representative.

Benefits at a glance

These exclusive special materials increase the life span of the sensors. This leads to:

- Cost savings for maintenance of the measuring point
- Quality improvements of the products
- Increased plant safety

The thermometer lines TAF11 and TAF16 have a modular design. The measurement inserts and thermowells can be ordered as spare parts via a standard order structure.

This saves costs,

- as only actually defective parts need to be exchanged
- due to optimized stock keeping

Temperature engineered solutions



Endress+Hauser offers both standardized and fully customized modular multipoint thermometers for various applications. Our portfolio of multipoint thermometers comprises:

- MultiSens Flex: 3D-customizable flexible sensors (with or without thermowell)
- MultiSens Linear: straight-profile sensors (with or without main thermowell)
- MultiSens Slim: Minimally invasive sensors embedded in a capillary tube
- MultiSens Bundle: Linear-bundled sensors (on a metallic rope)
- SkinPoint (surface-contact sensor)
- Accessories such as supporting systems and brackets.

Material selection, mechanical design, heat treatments and construction technics are the best in terms of product optimization.

Temperature engineered solutions – including tests, accessories and service – are planned and executed specifically with the aim of satisfying challenging customer requirements. We use specific requirements, e.g. process data and approved documentation such as drawings and calculations, as the basis for our solutions.

Temperature measurement in process reactors

Engineering services Endress+Hauser is a provider of technical solutions – therefore it is a matter of course that not only complete thermometers are provided but also the necessary engineering is implemented. “State-of-the-art” methods are used for engineering the solution e.g. the Finite Elements method, 3D-CAD models, etc. The Endress+Hauser specialists also offer on-site supervision or installation in order to manage teams and lead to a correct installation. This ensures that experts are available from the beginning of the project up to start-up. Moreover, Endress+Hauser offers support in the internal reactor design e.g. the engineering of the support options within the reactor. When engineering these support structures it is important that no channeling occurs which would lead to deterioration in the reactor performance. The necessary engineering information is obtained through onsite customer visits where the best solution is developed in cooperation with the process engineers.

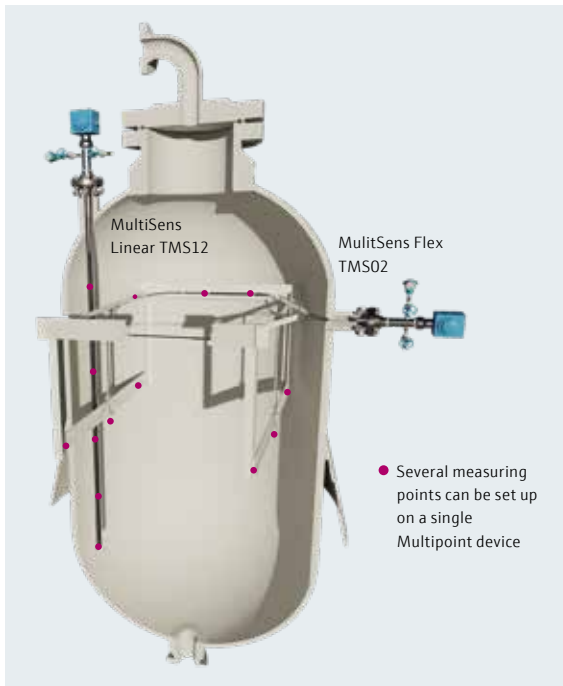

✓ Advantages at a glance

- Defective thermocouples can be replaced without switching off the process
- Increased safety thanks to a diagnostic chamber able to contain the process in the event of leakages through the primary seals (PED certified chamber)

Diagnostic chamber concept The diagnostic chamber is a very important component of some TES products, like TMS02 and TMS12, which allows to monitor continuously, through pressure and/or gas analysis, the complete product life cycle, enabling proactive maintenance strategies and safety monitoring.



Multipoint connection flange

Multipoint assemblies iTHERM MultiSens

Multipoint assemblies are standard or customized products for several applications from low to high pressure process reactors. In these applications a temperature profile for control of the process in the reactor is measured and recorded. The challenge is to be less invasive as possible and to have an high number of temperature probes, enabling the shortest response time.

Material selection, mechanical design and construction technics are the latest state-of-the-art in terms of product optimization, positioning Endress+Hauser as a global supplier continuously focused on reliable innovation.

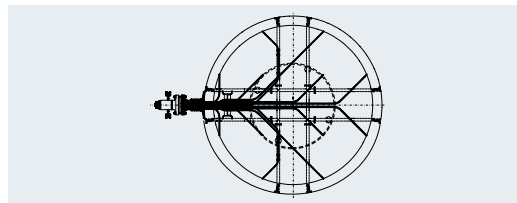

Measurement point positioning in a process reactor (top view)

SkinPoint thermocouples

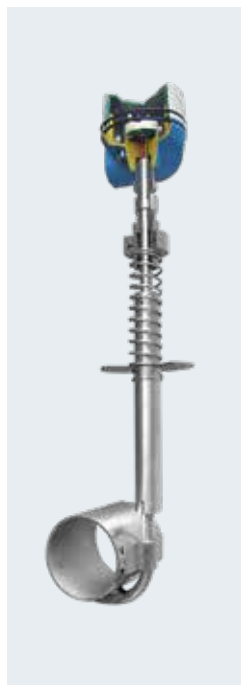
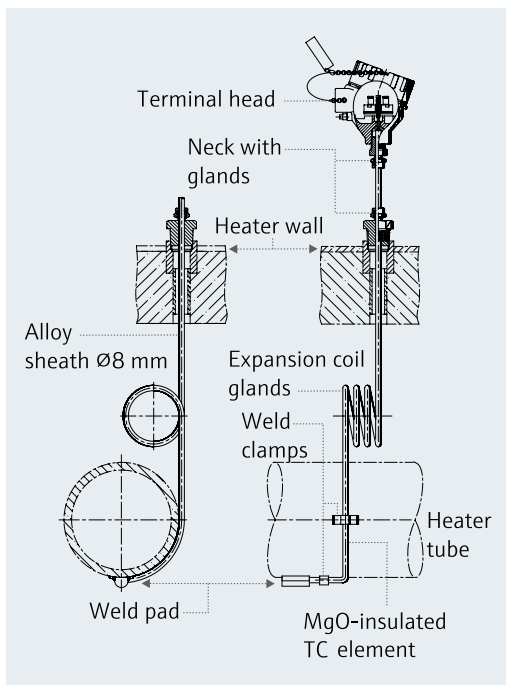

Surface temperature measurement may be requested by industrial processes when hot surfaces of reactors or pipes have to be monitored and invasion into the pipe or reactor must be avoided. Coil furnaces and reactors are the typical chemical and petrochemical plant equipment where SkinPoints are installed. Continuous temperature detection and heat exchange monitoring of the process medium flowing through pipe bundles, without affecting the stream's steadiness, is fundamental to guarantee the whole process efficiency and to check for deposit rates within the pipes that affect the quality of the products. High temperatures, the existence of aggressive burning gases and differential expansions of the heat exchanger pipe bundles are very demanding conditions.

Approvals and certificates

High standards at the engineering design stages and different tests during the production as well as final tests and controls counteract an early avoid and tear failure of the equipment.

Test center

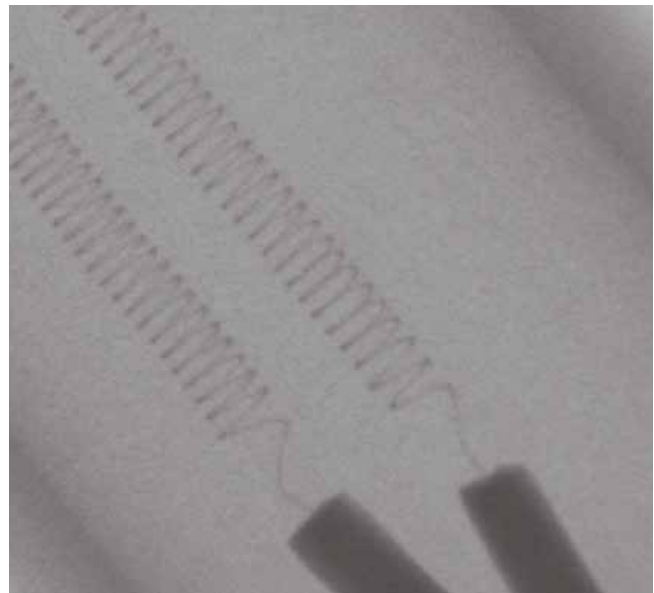

An extensive range of measurement and test equipment is available for quality control and continuous optimization of the thermometers, thermowells and transmitters. For example, microscopy, endoscopy and X-ray are used for optical testing of the quality of welded and soldered joints. The material and machining quality is verified by means of dye penetration testing, ultrasonic testing, helium leak testing, pressure endurance testing, insulation and vibration testing, along with a range of material testing techniques that are also non-destructive.

Of course, the response times of the inserts with and without a thermowell are determined in flowing water in an appropriate test facility in accordance with VDI/VDE 3522 or IEC EN 60751.

Using high-precision x-ray equipment, the tiniest details measuring up to 1 μm can be detected in thermometers without having to open or destroy them.

Calibration and approvals



With their know-how and excellent equipment (high stable temperature baths and furnaces, fixed point cells, precision thermometers) the accredited calibration laboratories realize calibration of thermometers to the lowest possible measurement uncertainty and traceable to national standards and the ITS90 international temperature scale:

- Fixed point calibration at the water triple point cell (0.01 °C) and the ice point (0.0 °C) with a measurement uncertainty of < 5 mK and at the nitrogen fixed point of -196 °C.
- Comparison calibration of resistance thermometers and thermocouples with precision thermometers from -80 to +400 °C in very homogenous and stable calibration baths (measurement uncertainty 20 to 100 mK) and up to 1500 °C in calibration furnaces with a measurement uncertainty of ≤ 500 mK.
- High precision resistance measurements (1 ppm accuracy) and thermo voltage measurements (sub-μV accuracy).
- Sensor-transmitter matching for additional reduction of the thermometer measurement uncertainty.

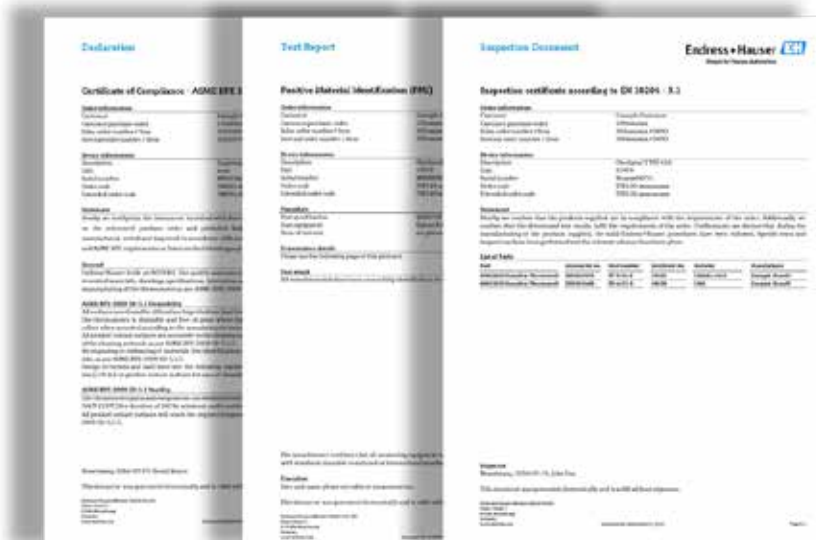

Certificates issued:

- Detailed works or Accredia-/DAkkS calibration certificates with measurement results according to ISO 17025, calibrating uncertainties according to GUM or DIN V ENV 13005 and identification curve approximations like Callendar-Van Dusen coefficients
- Testimonials in accordance with paragraph 3.1 EN 10204 regarding material compositions (if necessary with smelt composition), surface roughness and ferrite content

Planning, commissioning and maintenance tools

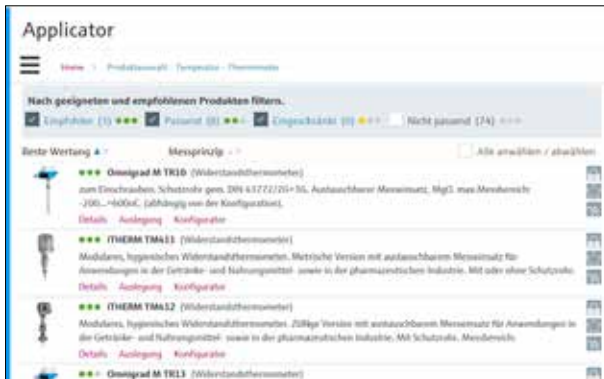

SELECTION

Applicator Selection

During the planning of measurement points the course is set right at the beginning, in the basic engineering phase. An optimally designed thermometer has many advantages:

- Reliable and accurate measured values
- Low risk of later device failures
- Constant process quality

For the choice of the suitable thermometer the most important parameters such as medium, pressure and temperature are requested in the Applicator Selection. With these details the tool makes an initial suggestion which can then be filtered further. The suggested device type technical data can be compared in a table. The result is a thermometer type which, on the one hand, meets all requirements but, on the other hand, is also not technically over dimensioned.

The efficient choice of a suitable thermometer saves engineering time and cost.



Further information:
www.endress.com/applicator



CONFIGURATION

Configurator

When configuring a measurement point numerous standards and guidelines must be taken into account. This software supports the necessary detailed engineering:

- Avoids time consuming catalog research.
- Automatically delivers the correct order code.
- Increases the engineering productivity.

The Configurator is a software which supports the configuration of the selected thermometer type by illustrations and a knowledge database in detail.

Not only all worldwide standards are deposited in the knowledge database for temperature measurement technology but also background information about the process industries, such as explosion protection and hygienic processes. The Configurator therefore leads to an ordering structure and increases the quality of the detail engineering.

Temperature measurement technology is the oldest measuring principle with an correspondingly long history. Over the years more than 50 important standards to be observed by process industries have established themselves worldwide. Through these standards the individual components of a temperature measurement point such as the measurement insert, thermowell, terminal head, transmitter etc. are easily defined. With modern software tools it is possible today to manage the complexity and easily design the suitable thermometer for the right application.



PRODUCTION

Common Equipment Record

When ordering a thermometer the result of the engineering is submitted to Endress+Hauser in form of an order structure. The associated data is not lost but is saved electronically as a birth certificate at the production of the thermometer. This database is called the "Common Equipment Record" and in turn is available to the customer for the complete life cycle of the thermometer.

This function is part of the Web supported Asset Management (W@M) software from Endress+Hauser. The customer can load all data to the device from the Internet and therefore optimize his own asset management. This is becoming more and more important in the process industries because, by optimizing supplies, considerable cost savings can be made in the life cycle of a production plant.

Therefore, in addition to the order details, the thermometer serial number and, if required, a measurement point identifier (TAG), calibration details and test certificates can be placed into the "Common Equipment Record". Since the customer can access all this data during operation:

- Access to information on the measurement point is easy.
- Spare parts are quickly found during the operation phase.
- Down time is minimized.

SET-UP

FieldCare and DeviceCare

For the operation and maintenance of field devices completely new prospects open up for the use of globally standardized "Field Device Technology" (FDT). With the assistance of "Device Type Managers" (DTM):

- all commonly used field devices,
- independent from manufacturer,
- can be set up using an operating software.

The software FieldCare and DeviceCare is used for these worldwide FDT/DTM standards and therefore simplifies the parameter setting of thermometers and field devices.

Basis functions are:

- Maintenance of the connection to the field devices (point to point or per fieldbus systems)
- Easily read display of all device parameters
- Configuration of measurement devices (online and offline)
- Documentation of configuration and measurement point data (also in PDF format)
- Archiving and storage of device data as files (up-/download)
- Device status display for fast fault diagnosis

Furthermore FieldCare offers extended functions which support the asset management of the customer. There is an automatic interface to W@M and the birth certificate of the field device. All data from the engineering phase is therefore passed on electronically via "Common Equipment Record" up to the device commissioning. This not only saves time but also avoids faults caused by mix-up.

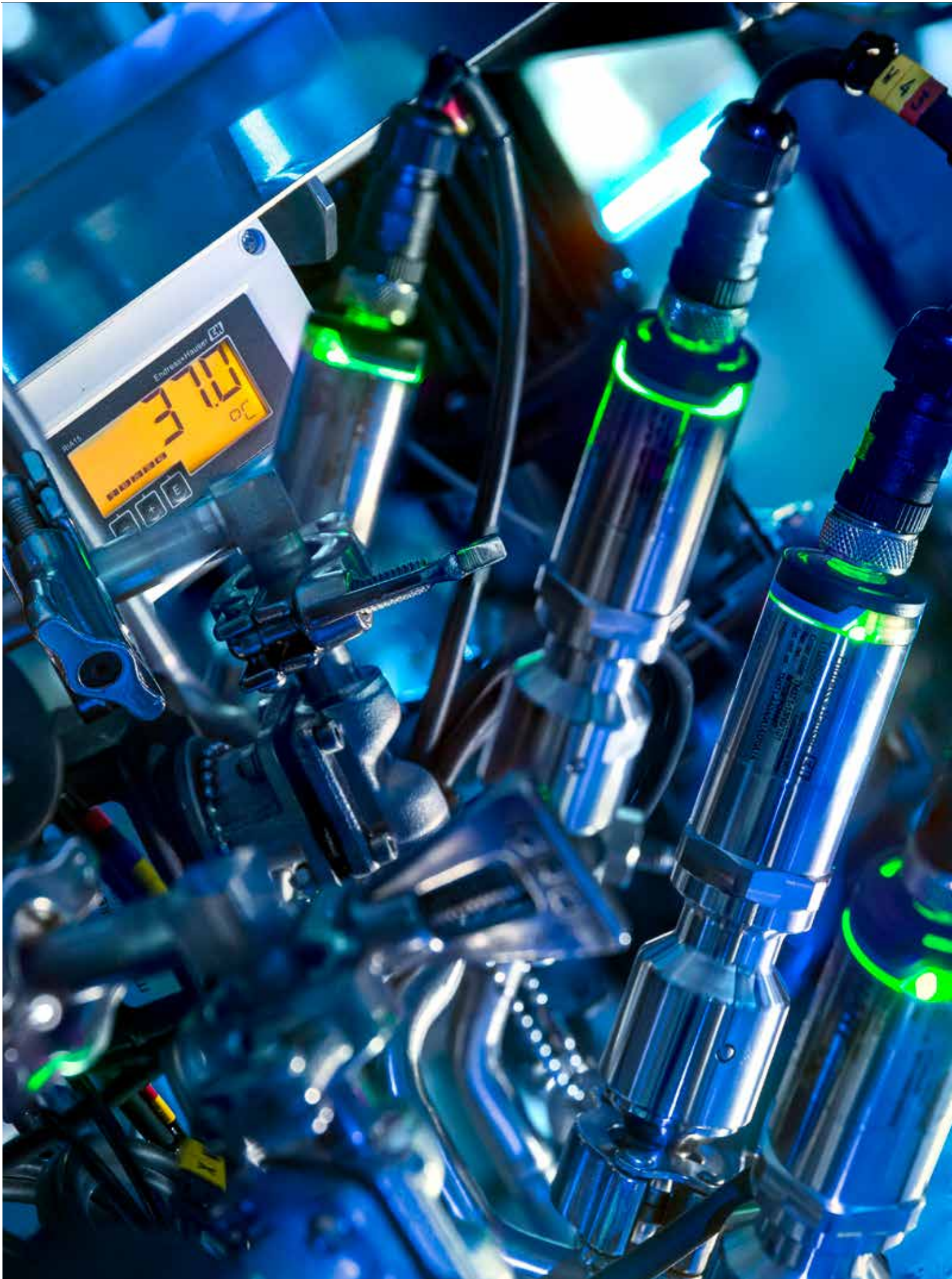

 **Further information**

- Calibration of thermometers CP00004R
- Temperature engineered solutions CP00003
- System products and data managers - FA00016K/09
- Tailor-made field instrumentation, solutions and services - FI00001Z



Have you found “Your” device?
We would be pleased to send you further detailed Technical Information.



See as download under:
www.endress.com/download

www.addresses.endress.com